



High Performance PTO Belt Driven Centrifugal Pump



PTOC-150 SERIES

- Suction 1-1/2" - Discharge 1-1/4"
- Stainless Steel Shaft and Wear Ring
- Chemical Resistant Valox® or Optional Cast Iron Impeller
- Standard Viton® Carbon/Ceramic seal or Optional Severe Duty Silicon Carbide Mechanical Seal
- Spring loaded idler absorbs shock of PTO engagement.
- Six models available - see back page
- BAC-15-PIN feature ensures proper alignment

Valox® is a registered trademark of GE Plastics.
Viton® is a registered trademark of DuPont Dow Elastomers.

600 RPM PERFORMANCE CHART

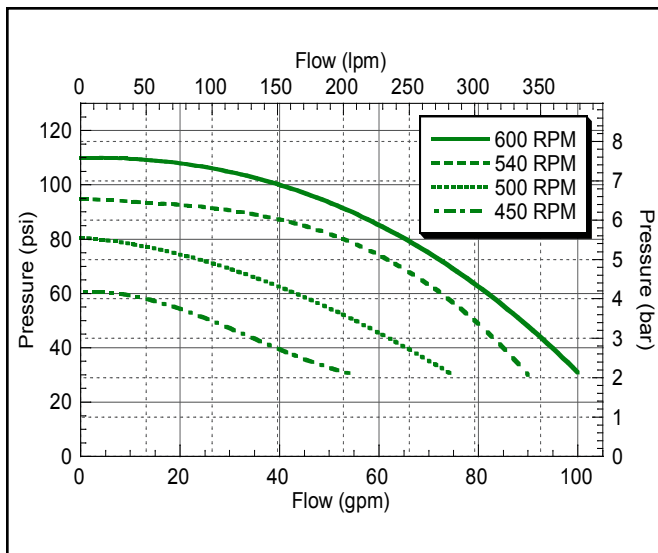

1000 RPM PERFORMANCE CHART

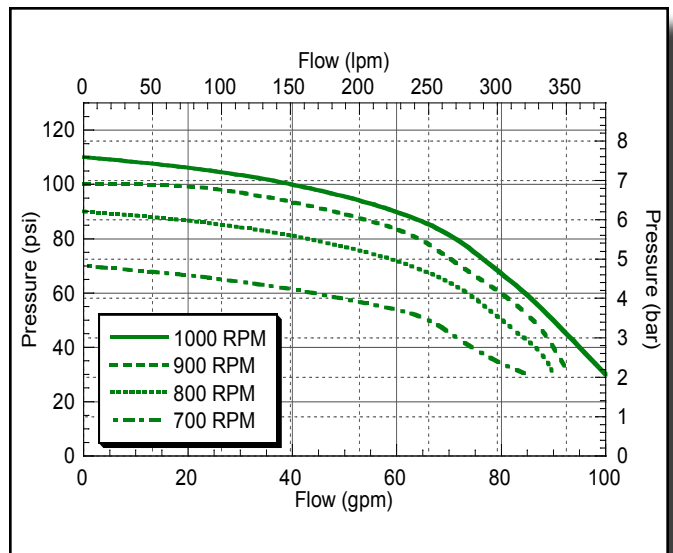

EXPLODED VIEW DRAWING

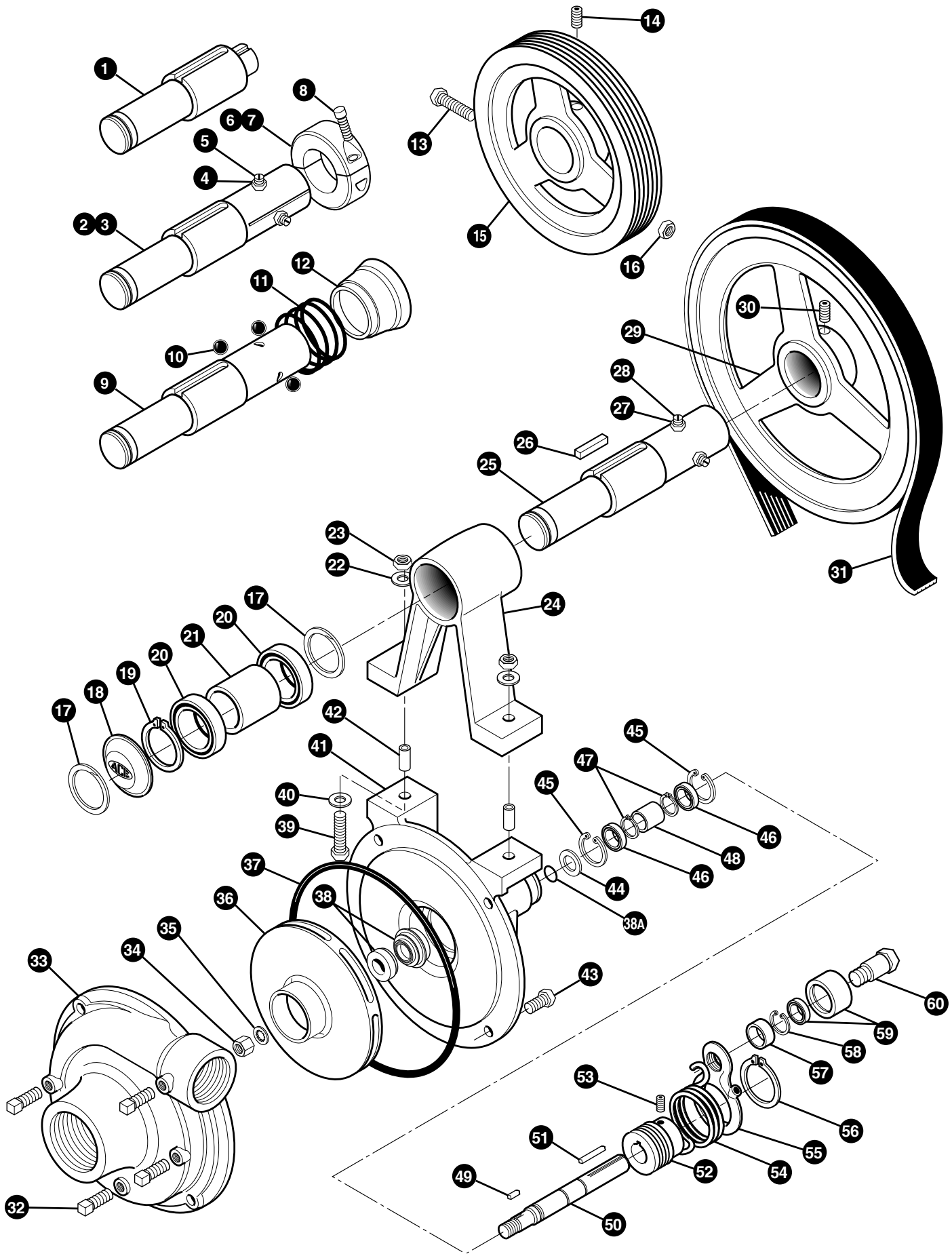

PARTS LIST

REF. #	PART #	EDP #	DESCRIPTION	REQ.
1	BAC-10-S	40190	1" Tumblerod stub drive shaft	1
2	BAC-10-175-20SP	40180	1-3/4" 20 Tooth PTO spline drive shaft, includes BAC-11-175	1
3	BAC-10-21SP	40220	1 3/8" 21 Tooth PTO spline drive shaft, includes BAC-11	1
4	40960	40960	3/8" NC jam nut	3
5	BAC-40	40940	3/8" NC slotted set screw	3
6	BAC-11-175	40236	Locking collar, split ring (for BAC-10-175-20SP shaft)	1
7	BAC-11	40235	Locking collar, split ring (for BAC-10-21SP shaft)	1
8	BAC-11-1	40237	Set screw (for BAC-11 and BAC-11-175 locking collar)	1
9	BAC-10-6SP-QC	40210	1-3/8" 6 Tooth PTO spline drive shaft for quick coupler	1
10	BAC-83-QC	41470	Ball for quick coupler	3
11	BAC-82-QC	41460	Spring for quick coupler	1
12	BAC-81-QC	41450	Ball retainer sleeve for quick coupler	1
13	41250	41250	5/16" NC x 3-1/4" hex head cap screw	1
14	41300	41300	3/8" NC x 5/8" allen head set screw	2
15	BAC-30-10-M-150	40751	7.9" P.D. x 2" Bore Poly-V pulley (for PTOC-150-1000-21SP)	1
15	BAC-30-175-150	40746	7.9" P.D. x 2-3/8" Bore Poly-V pulley (for PTOC-150-1000-20SP)	1
16	BAC-63	41260	5/16" NC self locking nut for tumblerod drive	1
17	BAC-34	40830	Internal snap ring, BAC-15 bearing housing	2
18	BAC-27-150-175-M	40506	Name plate (for PTOC-150-1000-20SP)	1
18	BAC-27-150-M	40501	Name plate (for PTOC-150-1000-21SP)	1
18	BAC-27-150-600	40512	Name plate (for PTOC-150-600)	1
19	BAC-35	40840	External snap ring, BAC-10 drive shaft	1
20	BAC-31-1	40781	Sealed ball bearing, BAC-10 drive shaft	2
21	BAC-38-1	40905	Bearing spacer, BAC-10 shaft	1
22	BAC-44	40990	3/8" Lock washer	2
23	BAC-45	41010	3/8" NC Hex nut	2
24	BAC-15	40340	PTO drive shaft bearing housing	1
24	BAC-15-B	40370	Tumblerod drive shaft bearing housing with mounting base	1
25	BAC-10-6SP	40200	1-3/8" 6 Tooth PTO spline drive shaft	1
26	BAC-51	41090	3/8" x 1/2" x 1-1/2" key, PTO drive shaft	1
27	40960	40960	3/8" NC jam nut	3
28	BAC-40	40940	3/8" NC slotted set screw	3
29	BAC-30-10-150	40741	11.6" P.D. x 2" Bore Poly-V pulley, 10 groove (for 600 RPM models)	1
30	41300	41300	3/8" NC x 5/8" allen head set screw	2
31①	BAC-28-10-150	40611	Poly-V Belt, 10 groove (for PTOC-150-600)	1
31②	BAC-28-10M-150	40621	Poly-V Belt, 10 groove (for PTOC-150-1000)	1
32	BAC-53	41110	1/8" NPT Pipe plug	3
32	41120	41120	1/8" NPT Pipe plug, stainless steel (optional)	3
33	BAC-12-150	40255	Volute 1-1/2" x 1-1/4", cast iron	1
34	BAC-23-A	40391	Nut, 3/8" NF hex, cad plated lock nut	1
35	BAC-24-HYD-SS	44000	Washer, 3/8", stainless steel	1
36	BAC-26-150	40445	Impeller, cast Iron with keyway(optional)	1
36	BAC-26-150-P	40446	Impeller, with keyway, thermoplastic	1
37①②③④	BAC-4-150	40015	"O" Ring volute seal	1
38④	BAC-7SC	40152	Silicon carbide mechanical seal (includes 40160) (optional)	1
38①②③	BAC-7V	40151	Viton mechanical seal (includes 40160 "O" Ring)	1
38A①②③④	40160	40160	"O" ring for mechanical seal	1
39	BAC-42	40970	3/8" NC x 2" Hex head cap screw	2
40	BAC-43	40980	3/8" Flat washer	2
41	BAC-14-150-MIA	40308	Mounting frame, machined for idler arm	1
42	BAC-15-PIN	40799	Alignment pin	2
43	40930	40930	3/8" NC x 3/4" hex head cap screw, stainless steel (optional)	4
43	40950	40950	3/8" NC x 3/4" hex head cap screw	4
44	BAC-54	41130	Slinger	1
45	BAC-33	40810	Internal snap ring for mounting frame	2
46	BAC-37	40870	Sealed ball bearing for pump shaft	2
47	BAC-32	40790	External snap ring for driven pump shaft	2
48	BAC-32-S	40795	Spacer for pump shaft	1
49	BACH-25	40420	Key for impeller, 1/8" x 1/8" x 1/2"	1
50	BAC-6-150/200-SS	40056	5/8" Driven Shaft, with keyway, stainless steel	1
51	BAC-50	41080	3/16" x 3/16" x 1-1/4" key	1
52	BAC-29-10-1.35	40675	1.35" P.D. x 5/8" Bore Poly-V pulley, 10 groove(PTOC-150-600)	1
52	BAC-29-10-1.7	40681	1.7" P.D. x 5/8" Bore Poly-V pulley, 10 groove(PTOC-150-1000)	1
53	BAC-57	41180	5/16" NC x 5/16" allen head set screw for BAC-29-10 pulley	2
54	BAC-5-150	40035	Idler mounted torsion spring for 150 series	1
55	BAC-13	40270	Idler arm	1
56	BAC-36	40850	External snap ring, BAC-13 idler arm	1
57	BAC-46	41020	5/8" Spacer	1
58	41070	41070	Retainer ring	1
59	BAC-55	41140	Idler bearing and outer roller assembly	1
60	BAC-47	41040	5/8" NC x 2-1/8" hex head idler cap screw	1
#	BAC-52	41100	1/4" cold shut, torque chain anchor	1
#	BAC-58	41190	Zerk fitting, 1/4" NPT, for idler arm	1
#	BAC-55-A	41150	Idler arm assembly (includes 55 through 60 and BAC-58)	-
#	BGKB-150	52605	Belt and shaft guard kit for all PTOC-150 pumps	-
①	RK-PTOC-150-600	51155	Repair kit for 600 RPM models, includes belt, seal, and "O" ring	-
②	RK-PTOC-150-1000	51255	Repair kit for 1000 RPM, includes belt, seal, and "O" ring	-
③	RK-FMC-150	52710	Repair kit for pump only, includes seal, and "O" ring	-
④	RK-FMCSC-150	52711	Repair kit for pump only, includes silicon carbide seal, and "O" ring	-
#	FMC-150-MIA	47008	Pump end only, machined to accept idler arm	-

Not shown in exploded view drawing.



PTO SHAFT OPTIONS:

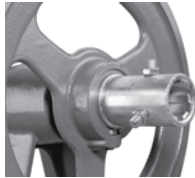

PTOC-150-600-6SP



PTOC-150-600-6SPQC



PTOC-150-600-B



PTOC-150-1000-21SP

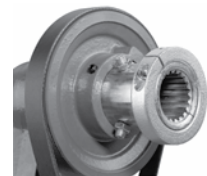

PTOC-150-1000-20SP



PTOC-150-1000-B

DIMENSIONS

