

2024  
PRODUCT CATALOG



**TERREMAX**<sup>®</sup>  
LIQUID HANDLING PRODUCTS



**Develop.**



**Depend.**



**Deliver.**

Family Owned & Operated Since 1979

# NEW PRODUCTS



## from TerreMax

### IBC Spin Weld Ball Valves (Pg 6)

#### IBC Spin Weld Ball Valves

PART #	DESCRIPTION
BCF60	2" Cam IBC valve; Viton® seal; Yellow cap; 60mm collar thread
BCMT60	2" NPT IBC valve; Viton® seal; Yellow cap; 60mm collar thread
BCF60C	2" Cam IBC valve; Viton® seal; Yellow cap w/ check valve; 60mm collar thread
BCF75	2" Cam IBC valve; Viton® seal; Yellow cap; 75mm collar thread
BCMT75	2" NPT IBC valve; Viton® seal; Yellow cap; 75mm collar thread
BCF75C	2" Cam IBC valve; Viton® seal; Yellow cap w/ check valve; 75mm collar thread



BCF60C & BCF75C w Check Valve



Foil Seal



BCF60



BCMT60



BCF75



BCMT75



BCF60C



BCF75C

### Valve Mounting Plates (Pg 12)

#### Valve Mounting Plates

PART #	DESCRIPTION	FITS VALVES
V10270	Straight Mounting Bracket	V100FPY, V125Y
V10271	90° Mounting Bracket	V100FPY, V125Y



V10270



V10271

### Manifold - 3Way Ball Valves (Pg 17)

#### 3 WAY BOTTOM LOAD BALL VALVES

PART #	DESCRIPTION
MV100BL	1" ; 3 Way Bottom Load Manifold
MV220BL	2" FP ; 3 Way Bottom Load Manifold
MV300BL	2" FP ; 3 Way Bottom Load Manifold

#### 3 WAY SIDE LOAD BALL VALVES

PART #	DESCRIPTION
MV100SL	1" ; 3 Way Side Load Manifold
MV220SL	2" FP ; 3 Way Side Load Manifold



MV220BL

MV300BL

MV100BL

MV100SL

MV220SL

# NEW PRODUCTS



## from TerreMax

### Manifold Flange Clamps (Pg 23)

#### T Bolt Flange Clamps

PART #	DESCRIPTION
FC220TB	2" FP T-Bolt Flange Clamp; Stainless Steel
FC300TB	3" T-Bolt Flange Clamp; Stainless Steel

#### Hinge Casted Clamps

PART #	DESCRIPTION
FC220HC	2" FP Hinge Flange Clamp; Stainless Steel
FC300HC	3" FP Hinge Flange Clamp; Stainless Steel



### Perforated Line Strainer Screen (Pg 37)

#### Perforated Line Strainer Screens

PART #	DESCRIPTION
PLS250SS	50 Mesh for 1-1/2" & 2" Y-Strainers; 316SS
PLS280SS	80 Mesh for 1-1/2" & 2" Y-Strainers; 316SS



### Additional Sizes & Updated Design (pg 44 & 45)

#### Short Nipple



PART #	DESCRIPTION
NIP038-SH	3/8" Male NPT Short Poly Nipple
NIP050-SH	1/2" Male NPT Short Poly Nipple
NIP075-SH	3/4" Male NPT Short Poly Nipple
NIP100-SH	1" Male NPT Short Poly Nipple
NIP125-SH	1-1/4" Male NPT Short Poly Nipple
NIP150-SH	1-1/2" Male NPT Short Poly Nipple
NIP200-SH	2" Male NPT Short Poly Nipple
NIP300-SH	3" Male NPT Short Poly Nipple

#### 90° Hose Barb



PART #	DESCRIPTION
HB02503890	1/4" Male NPT x 3/8" Hose Barb 90° Elbow
HB02505090	1/4" Male NPT x 1/2" Hose Barb 90° Elbow
HB05003890	1/2" Male NPT x 3/8" Hose Barb 90° Elbow
HB10007590	1" Male NPT x 3/4" Hose Barb 90° Elbow
HB10012590	1" Male NPT x 1-1/4" Hose Barb 90° Elbow
HB12515090	1-1/4" Male NPT x 1-1/2" Hose Barb 90° Elbow
HB15012590	1-1/2" Male NPT x 1-1/4" Hose Barb 90° Elbow
HB20015090	2" Male NPT x 1-1/2" Hose Barb 90° Elbow

### T & Y Line Strainers (pg 21-22; 34-36)

- Heavy Duty Glass Reinforced Polypropylene
- Clean Out Plug
- EPDM Gaskets; Viton® available
- Replacement parts available



#### FEMALE THREADED T STRAINER

LST10050



#### MANIFOLD FLANGE Y STRAINER

MLS22020

<b>Ball Valve Series</b>	Single Union .....	5
	3 Way .....	5
	HM Quick Shut Off .....	5
	IBC Spin Weld Ball Valves .....	6
	Bolted Polypropylene Ball Valves: 4 Bolt - 6 Bolt - 8 Bolt - Compact .....	7-11
	Angle Valve .....	11
	Valve Accessories & Sealant .....	11-12
<b>Manifold Flange Series</b>	Manifold Valves .....	14-17
	Sweep - Male NPT .....	18
	Sweep - Hose Barb .....	18
	Sweep .....	18
	Hose Barb .....	18
	Coupling .....	18
	Coupling Reducer .....	19
	Male NPT .....	19
	Male Adapter .....	19
	45° Coupling .....	19
	Plug .....	19
	Female Coupler .....	19
	Hose Barb Tee .....	20
	Female NPT .....	20
	Cross .....	20
	Tee .....	20
	Manifold Bulkhead .....	20
Manifold Flange Strainers .....	21-22	
Manifold Flange Clamps & Gaskets .....	23-24	
<b>Couplers</b>	Safety Camlock .....	26
	Camlock .....	27-28
	2" x 3" Camlocks .....	29
	Plug w Handle .....	28; 29
	Garden Hose Camlocks .....	29
	Replacement Gaskets .....	29
	Shims .....	29
	Angle Camlocks .....	30
<b>Clamps</b> .....	31-32	
<b>Strainers</b>	Female Threaded "T" .....	34
	Female Threaded "Y" .....	35-36
	Replacement Line Strainer Screens .....	37
	Bowl & Basket Strainers .....	38
<b>Bulkhead Fittings &amp; Bulkhead Gaskets</b> .....	40-41	
<b>Siphon Tube</b> .....	41	
<b>Bolted Tank Fittings</b> .....	41	
<b>Dry Poppet</b> .....	42	
<b>Schedule 80 -Heavy Duty</b>	Straight Adapter .....	44
	Female Thread Hose Barb .....	44
	90° Sweep Hose Barb .....	44
	90° Hose Barb .....	44
	Straight Hose Mender .....	44
	Elbow .....	45
	Reducing Coupling .....	45
	Street Elbow .....	45
	Reducing Nipple .....	45
	Nipple .....	45
	Reducer Bushing .....	45
	Coupling .....	45
	Tee .....	46
	Tee w Gauge Port .....	46
	45° Street Elbow .....	46
	Pipe Caps .....	46
	Plug .....	46
Steel Plated Straight Adapter .....	46	
Pin Lug Coupler .....	46	
<b>Fittings- Nylon &amp; Polypropylene</b>		
Hose Fittings .....	48-51	
Pipe Fittings .....	52-54	
Garden Hose Fittings .....	55-57	
Nozzle Fittings .....	58-59	
<b>Spray Components</b>	Gauges .....	60
	Boom Clamps .....	60
	Nozzle Bodies .....	61
	Winged Bayonet Caps .....	62
	Spray Tips Filters .....	62
	Spray Wands .....	62
	Solenoid Valves .....	63
Wiring Harnesses .....	63	
<b>Rope Wick</b>	String Wing & Mounts .....	64
	Rope Wick Fittings & Kits .....	65
	Weed Thief .....	65

# Ball Valves

## Selection

TerreMax valves are available in sizes ranging from 1/2" to 4".

## Quality

Our primary resin is a high strength custom blended glass filled polypropylene.

## Location

TerreMax takes pride in the fact that most of our valves are made on site at our Indiana manufacturing location.

## Experience

We have been producing high quality ball valves for over 2 decades.

## Variety

We have a variety of styles and configurations. Choose from pipe threaded valves, manifold, garden hose valves, full port, standard port, and many more.

## Custom

Can't find what you're looking for in our standard valve line? No worries, we make custom valves as well!

## Knowledge

Let us use our expertise to help you make the right choice.

### FEATURED ITEMS —

#### Valves (pgs 5-11)

2" Standard Port  
Valve Combinations



2" Full Port  
Valve Combinations



3" Full Port  
Valve Combinations



Manifold  
Valve Combinations



Stainless Steel  
Ball, Stem and Handle  
Valve Combinations



Stem Packing & Stem O-Ring  
Body O-Ring

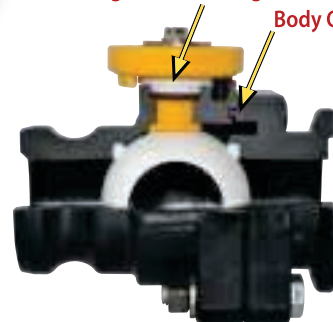

**The TerreMax Advantage**

# BALL VALVES



SU050E & SU075E

SU100E & SU125E



SU150E & SU200E

## Single Union Valves

- Sturdy Construction, fiberglass reinforced polypropylene body
- PTFE seats for smooth operation
- E.P.D.M. seals standard
- 125 P.S.I. @ 140° F

PART #	DESCRIPTION
SU050E	1/2" Female NPT
SU075E	3/4" Female NPT
SU100E	1" Female NPT
SU125E	1 1/4" Female NPT
SU150E	1 1/2" Female NPT
SU200E	2" Female NPT

\*\*DO NOT UNASSEMBLE WHILE UNDER PRESSURE



## 3 Way Valve

- Sturdy Construction, fiberglass reinforced polypropylene body
- PTFE seats for smooth operation
- E.P.D.M. seals standard
- 125 P.S.I. @ 140° F

PART #	DESCRIPTION
SU050BL	1/2" Female NPT
SU075BL	3/4" Female NPT
SU100BL	1" Female NPT
SU125BL	1 1/4" Female NPT
SU150BL	1 1/2" Female NPT
SU200BL	2" Female NPT

\*\*DO NOT UNASSEMBLE WHILE UNDER PRESSURE



## HM Quick Shut Off Valve

- One quarter turn polypropylene ball valve
- Used in liquid plumbing application as a quick shut off valve
- 75 P.S.I.

PART #	DESCRIPTION
HM50B	1/2" Female NPT With Buna "O" Ring
HM75B	3/4" Female NPT With Buna "O" Ring
HM50V	1/2" Female NPT With Viton® "O" Ring
HM75V	3/4" Female NPT With Viton® "O" Ring

## IBC SPIN WELD BALL VALVES



PART #	STYLE	GASKET	DESCRIPTION
BCF60	Mauser®	Viton®	2" Cam IBC valve; Viton® seal; Yellow cap; 60mm collar thread
BCMT60	Mauser®	Viton®	2" NPT IBC valve; Viton® seal; Yellow cap; 60mm collar thread
BCF60C	Mauser®	Viton®	2" Cam IBC valve; Viton® seal; Yellow cap w/ check valve; 60mm collar thread
BCF75	Schutz®	Viton®	2" Cam IBC valve; Viton® seal; Yellow cap; 75mm collar thread
BCMT75	Schutz®	Viton®	2" NPT IBC valve; Viton® seal; Yellow cap; 75mm collar thread
BCF75C	Schutz®	Viton®	2" Cam IBC valve; Viton® seal; Yellow cap w/ check valve; 75mm collar thread

**Valves feature:**

- PTFE Seats
- Viton® Stem O-Ring
- Viton® Collar Gaskets
- Precision molded polypropylene is reinforced with fiberglass for additional strength.
- Foil Seal
- Tamper Evidence Pin

## SPIN WELD BALL VALVE ACCESSORIES

		
211FPT	V20207	200CAP
PART #	DESCRIPTION	
211FPT	2" Female NPT Cap - Yellow	
V20207	12" Self-Anchoring Polyurethane Tether	
200CAP	2" CAP for Male Adapter	



## FEMALE NPT x FEMALE NPT

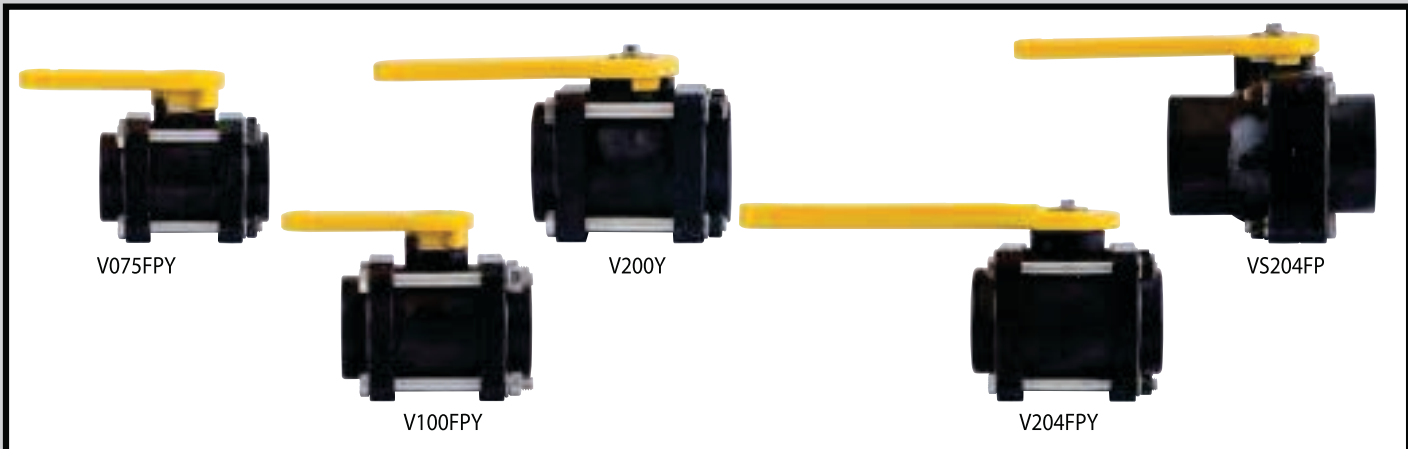

PART #	QTY	PSI	PORT	DESCRIPTION	HANDLE
V050FPY	35 / Box	150	3/4"	1/2" Female NPT x 1/2" Female NPT	V10153AY
V075FPY	35 / Box	150	3/4"	3/4" Female NPT x 3/4" Female NPT	V10153AY
V100Y	35 / Box	150	3/4"	1" Female NPT x 1" Female NPT	V10153AY
V100FPY	24 / Box	150	1"	1" Female NPT x 1" Female NPT	V10153AY
V125Y	24 / Box	150	1"	1-1/4" Female NPT x 1-1/4" Female NPT	V10153AY
V125FPY	15 / Box	150	1-1/2"	1-1/4" Female NPT x 1-1/4" Female NPT	V20153Y
V150FPY	15 / Box	150	1-1/2"	1-1/2" Female NPT x 1-1/2" Female NPT	V20153Y
V200Y	15 / Box	150	1-1/2"	2" Female NPT x 2" Female NPT	V20153Y
V204FPY	8 / Box	100	2"	2" Female NPT x 2" Female NPT	V25153Y
VS204FP	16 / Box	100	2"	2" Female NPT x 2" Female NPT	VS25153

## FEMALE NPT x FEMALE NPT



PART #	QTY	PSI	PORT	DESCRIPTION	HANDLE
V200FPY	8 / Box	100	2"	2" Female NPT x 2" Female NPT	V25153Y
V300Y	8 / Box	100	2-1/2"	3" Female NPT x 3" Female NPT	V25153Y
V300FPY	6 / Box	100	3"	3" Female NPT x 3" Female NPT	V25153Y
V400FPY	2 / Box	100	4"	4" Female NPT x 4" Female NPT	V20154Y

### Valves feature:

- Stainless Steel Bolts
- Precision molded in polypropylene.
- Viton® "O" rings.
- Polypropylene is reinforced with fiberglass for additional strength.
- Self-Aligning ball moves freely against the Teflon® seats for smooth operation.
- The valve opens and closes with little pressure on the handle.
- Teflon® self-lubricating stem bushings and seats cannot stick or bind.
- Ball is diamond turned after molded to make it spherically perfect, which provides precise contact between ball & seat





## MALE NPT x MALE CAM ADAPTER



PART #	QTY	PSI	PORT	DESCRIPTION	HANDLE
VSFMT200	20 / Box	100	1-1/2"	2" Male NPT x 2" Male Adapter	VS20152SH
VSFMT204FP	14 / Box	100	2"	2" Male NPT x 2" Male Adapter	VS25153
VSFMT204HSFP	14 / Box	100	2"	2" Male NPT x 2" Male Adapter w SS Ball, Stem & Handle	VS20101SS
VFMT204FPY	6 / Box	100	2"	2" Male NPT x 2" Male Adapter	V25153Y
VSFMT300FP	5 / Box	100	3"	3" Male NPT x 3" Male Adapter	V25153Y
VSFMT300HSFP	5 / Box	100	3"	3" Male NPT x 3" Male Adapter w SS Ball, Stem & Handle	VS30101SS

## FEMALE NPT x MALE CAM ADAPTER



PART #	QTY	PSI	PORT	DESCRIPTION	HANDLE
VSF200	14 / Box	100	1-1/2"	2" Female NPT x 2" Male Adapter	VS20152SH
VSF204FP	12 / Box	100	2"	2" Female NPT x 2" Male Adapter	VS25153
VSF204HSFP	12 / Box	100	2"	2" Female NPT x 2" Male Adapter w SS Ball, Stem & Handle	VS20101SS
VF204FPY	6 / Box	100	2"	2" Female NPT x 2" Male Adapter	V25153Y

### Valves feature:

- Compact Design
- Precision molded in polypropylene.
- Stainless Steel Bolts
- Polypropylene is reinforced with fiberglass for additional strength.
- Viton® "O" rings.
- Teflon® self-lubricating stem bushings and seats cannot stick or bind.

### Add'l features of VS Valve w SS Ball:

- Stainless Steel Ball, Handle, Stem and Bolts
- Locking Handle



## HOSE BARB x MALE NPT



PART #	QTY	PSI	PORT	DESCRIPTION	HANDLE
VSHBMT204FP	12 / Box	100	2"	2" Hose Barb x 2" Male NPT	VS25153
VSHBMT204HSFP	12 / Box	100	2"	2" Hose Barb x 2" Male NPT w SS Ball, Stem & Handle	V20101SS
VSHBMT300FP	5 / Box	100	3"	3" Hose Barb x 3" Male NPT	V25153Y
VSHBMT300HSFP	5 / Box	100	3"	3" Hose Barb x 3" Male NPT w SS Ball, Stem & Handle	VS30101SS



PART #	QTY	PSI	PORT	DESCRIPTION	HANDLE
VSMT200	14 / Box	100	1-1/2"	2" Male NPT x 2" Female NPT	VS20152SH
VSMT204FP	16 / Box	100	2"	2" Male NPT x 2" Female NPT	VS25153
VSMT204HSFP	16 / Box	100	2"	2" Male NPT x 2" Female NPT w SS Ball, Stem & Handle	VS20101SS
VMT204FPY	6 / Box	100	2"	2" Male NPT x 2" Female NPT	V25153Y

## MALE NPT x MALE NPT

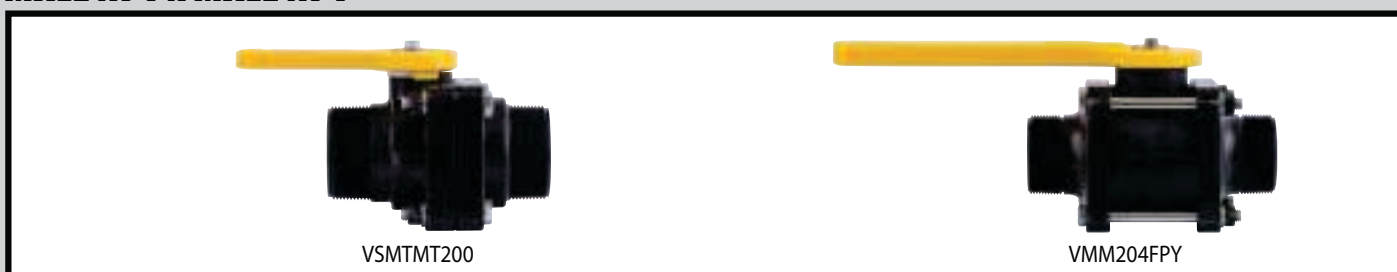

PART #	QTY	PSI	PORT	DESCRIPTION	HANDLE
VSMTMT200	14 / Box	100	1-1/2"	2" Male NPT x 2" Male NPT	VS20152SH
VMM204FPY	9 / Box	100	2"	2" Male NPT x 2" Male NPT; Full Port	V25153Y

### Valves feature:

- Compact Design
- Precision molded in polypropylene.
- Stainless Steel Bolts
- Polypropylene is reinforced with fiberglass for additional strength.
- Viton® "O" rings.
- Teflon® self-lubricating stem bushings and seats cannot stick or bind.

### Add'l features of VS Valve w SS Ball:

- Stainless Steel Ball, Handle, Stem and Bolts
- Locking Handle



## SMART-Connect™ HOSE BARB x FEMALE CAM COUPLER



PART #	QTY	PSI	PORT	DESCRIPTION	HANDLE
VSHBD204FP	10 / Box	100	2"	2" Hose Barb x 2" Female Coupler	VS25153
VSHBD204HSFP	10 / Box	100	2"	2" Hose Barb x 2" Female Coupler w SS Ball, Stem & Handle	VS20101SS
VSHBD300FP	3 / Box	100	3"	3" Hose Barb x 3" Female Coupler	V25153Y
VSHBD300HSFP	3 / Box	100	3"	3" Hose Barb x 3" Female Coupler w SS Ball, Stem & Handle	VS30101SS

## SMART-Connect™ MALE CAM ADAPTER x FEMALE CAM ADAPTER



PART #	QTY	PSi	PORT	DESCRIPTION	HANDLE
VSFD204FP	7 / Box	100	2"	2" Male Adapter x 2" Female Coupler	VS25153
VSFD204HSFP	7 / Box	100	2"	2" Male Adapter x 2" Female Coupler w SS Ball, Stem & Handle	VS20101SS
VSFD300FP	4 / Box	100	3"	3" Male Adapter x 3" Female Coupler	V25153Y
VSFD300HSFP	4 / Box	100	3"	3" Male Adapter x 3" Female Coupler w SS Ball, Stem & Handle	VS30101SS

### Valves feature:

- Compact Design
- Precision molded in polypropylene.
- Stainless Steel Bolts
- Polypropylene is reinforced with fiberglass for additional strength.
- Viton® "O" rings.
- Teflon® self-lubricating stem bushings and seats cannot stick or bind.

### Add'l features of VS Valve w SS Ball:

- Stainless Steel Ball, Handle, Stem and Bolts
- Locking Handle



## MALE CAM ADAPTER x HOSE BARB



VSFHB204FP



VSFHB300FP

PART #	QTY	PSi	PORT	DESCRIPTION	HANDLE
VSFHB204FP	10	100	2"	2" Male Cam Adapter x 2" Hose Barb	VS25153
VSFHB300FP	4	100	3"	3" Male Cam Adapter x 3" Hose Barb	V25134

## NOZZLE VALVE w 90° SWEEP



VA200FP

PART #	PSi	PORT	DESCRIPTION	HANDLE
VA200FP	100	2"	2" Female NPT Nozzle Valve w 90° Sweep	V25152

### Valves feature:

- Compact Design
- Stainless Steel Bolts
- Viton® "O" rings.
- Precision molded in polypropylene.
- Polypropylene is reinforced with fiberglass for additional strength.
- Teflon® self-lubricating stem bushings and seats cannot stick or bind.

## Thread Sealant

PART #	QTY	DESCRIPTION
RS21	24 / Box	RectorSeal® No. 21™ (8oz.-24/case)
RSTB	24 / Box	RectorSeal® Tru-Blu™ (8oz.-24/case)





## Nozzle

• Polypropylene construction

PART	DESCRIPTION
V10161	1" Male NPT; 45° Nozzle



V10270



V25270



V10271



V25271

## Valve - Mounting Plates

• 316 Stainless Steel construction

**NEW**

**NEW**

PART #	DESCRIPTION	FITS VALVES
V10270	Straight Mounting Bracket	V100FPY, V125Y
V25270	Straight Mounting Bracket	V125FPY, V150FPY, V200Y
V10271	90° Mounting Bracket	V100FPY, V125Y
V25271	90° Mounting Bracket	V125FPY, V150FPY, V200Y



## Valve Carry Handle

• 316 Stainless Steel construction  
• Fits most bolted valves 1-1/4" full port & above

PART #	DESCRIPTION
V25272	Valve Handle

# Manifold Flange Series

## FEATURED ITEMS —

Hose Barb Tee



Female Coupler



Manifold Bulkhead



### ***Selection***

The Manifold Series by TerreMax® includes valves, fittings, line strainers, clamps and gaskets.

### ***Durability***

TerreMax's fittings are utilized for a variety of agricultural, plumbing and industrial liquid-handling solutions.

### ***Polypropylene***

Our resin is a high-strength, custom blended, glass-filled polypropylene.

### ***Knowledge***

Let us use our expertise to help you make the right choice.

### ***Experience***

We have been producing high quality fittings for over 4 decades.



## FLANGE x FLANGE

MV100CF                      MV200CF                      MV220CF                      MV300CF

PART #	QTY	PSi	PORT	DESCRIPTION	HANDLE
MV100CF	24 / Box	150	1"	1" Flange x 1" Flange	V10153AY
MV200CF	15 / Box	150	1-1/2"	2" Flange x 2" Flange	V20153Y
MV220CF	14 / Box	100	2"	2" FP Flange x 2" FP Flange	V25153Y
MV300	8 / Box	100	2-1/2"	3" Flange x 3" Flange	V25153Y
MV300CF	6 / Box	100	3"	3" Flange x 3" Flange	V25153Y

## FLANGE x HOSE BARB

MVSHB220FP                      MVSHB220HSFP                      MVSHB300FP                      MVSHB300HSFP

PART #	QTY	PSi	PORT	DESCRIPTION	HANDLE
MVSHB220FP	10 / Box	100	2"	2" FP Flange x 2" Hose Barb	VS25153
MVSHB220HSFP	10 / Box	100	2"	2" FP Flange x 2" Hose Barb w SS Ball, Stem & Handle	VS20101SS
MVSHB300FP	5 / Box	100	3"	3" Flange x 3" Hose Barb	V25153Y
MVSHB300HSFP	5 / Box	100	3"	3" Flange x 3" Hose Barb w SS Ball, Stem & Handle	VS30101SS

## FLANGE x FEMALE NPT

MVS220FP                      MVS204HSFP

PART #	QTY	PSi	PORT	DESCRIPTION	HANDLE
MVS220FP	14 / Box	100	2"	2" FP Flange x 2" Female NPT	VS25153
MVS204HSFP	14 / Box	100	2"	2" FP Flange x 2" Female NPT w SS Ball, Stem & Handle	VS20101SS

## FLANGE x FLANGE

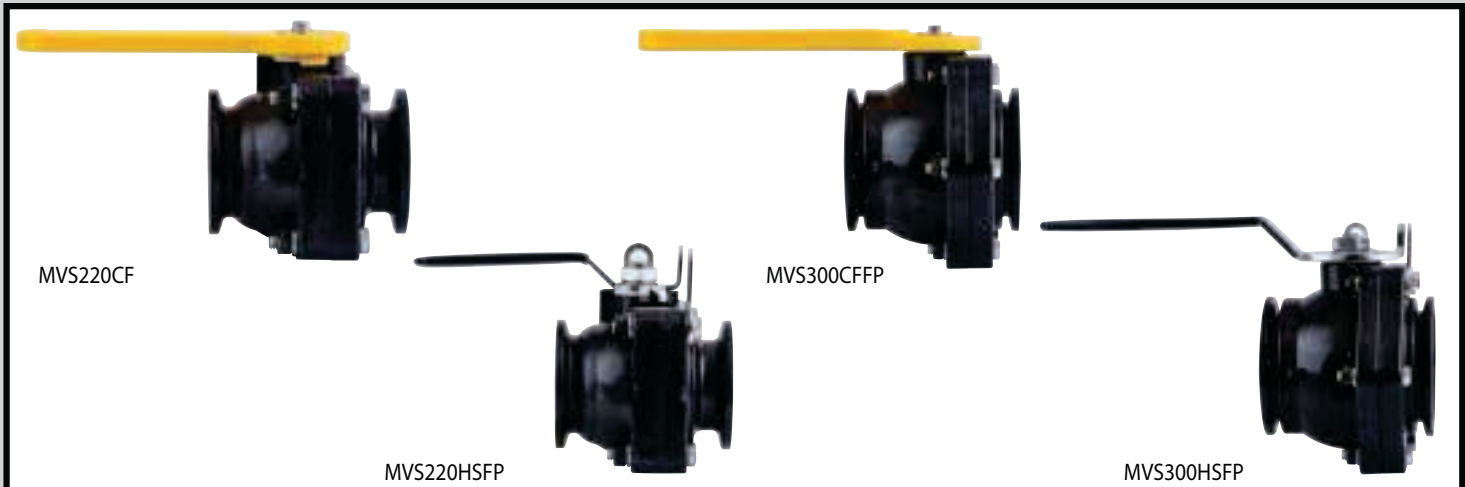

PART #	QTY	PSi	PORT	DESCRIPTION	HANDLE
MVS220CF	14 / Box	100	2"	2" FP Flange x 2" FP Flange	VS25153
MVS220HSFP	14 / Box	100	2"	2" FP Flange x 2" FP Flange w SS Ball, Stem & Handle	VS20101SS
MVS300CFPP	8 / Box	100	3"	3" Flange x 3" Flange	V25153Y
MVS300HSFP	8 / Box	100	3"	3" Flange x 3" Flange w SS Ball, Stem & Handle	VS30101SS

## FLANGE x MALE CAM ADAPTER

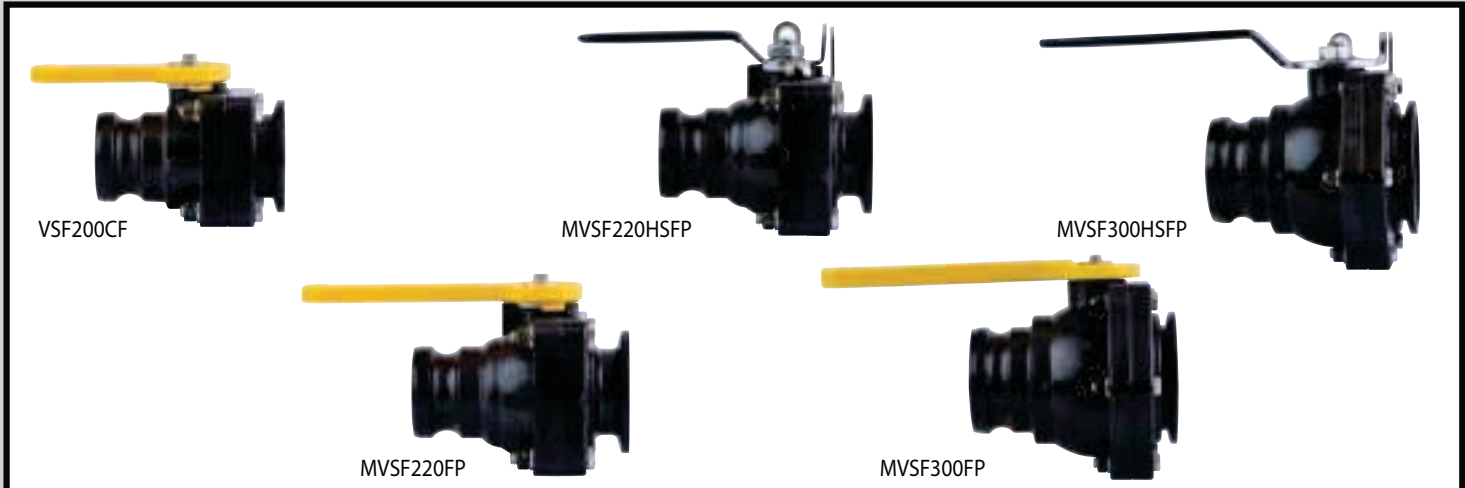

PART #	QTY	PSi	PORT	DESCRIPTION	HANDLE
VSF200CF	14 / Box	100	1-1/2"	2" Flange x 2" Male Adapter	VS20152SH
MVSF220FP	12 / Box	100	2"	2" FP Flange x 2" Male Adapter	VS25153
MVSF220HSFP	12 / Box	100	2"	2" FP Flange x 2" Male Adapter w SS Ball, Stem & Handle	VS20101SS
MVSF300FP	5 / Box	100	3"	3" Flange x 3" Male Adapter	V25153Y
MVSF300HSFP	5 / Box	100	3"	3" Flange x 3" Male Adapter w SS Ball, Stem & Handle	VS30101SS

### Valves feature:

- Compact Design
- Stainless Steel Bolts
- Viton® "O" rings.
- Precision molded in polypropylene.
- Polypropylene is reinforced with fiberglass for additional strength.
- Teflon® self-lubricating stem bushings and seats cannot stick or bind.

### Add'l features of VS Valve w SS Ball:

- Stainless Steel Ball, Handle, Stem and Bolts
- Locking Handle





## FLANGE x MALE NPT

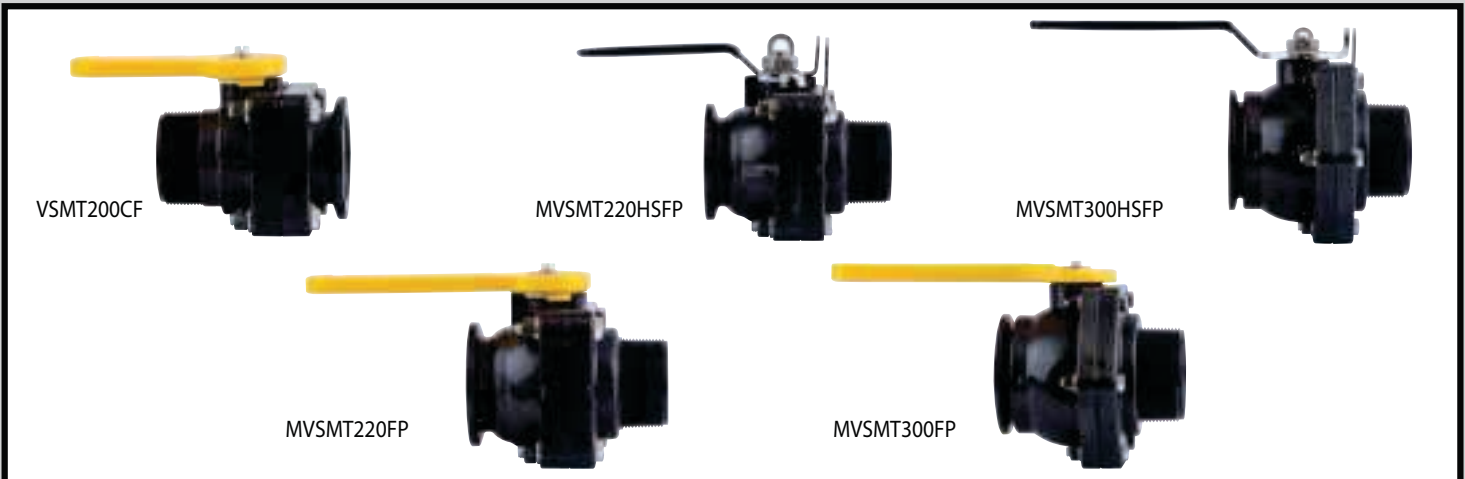

PART #	QTY	PSI	PORT	DESCRIPTION	HANDLE
VSMT200CF	18 / Box	100	1-1/2"	2" Flange x 2" Male NPT	VS20152SH
MVSMT220FP	10 / Box	100	2"	2" FP Flange x 2" Male NPT	VS25153
MVSMT220HSFP	10 / Box	100	2"	2" FP Flange x 2" Male NPT w SS Ball, Stem & Handle	VS20101SS
MVSMT300FP	10 / Box	100	3"	3" Flange x 3" Male NPT	V25153Y
MVSMT300HSFP	10 / Box	100	3"	3" Flange x 3" Male NPT w SS Ball, Stem & Handle	VS30101SS



## SMART-Connect™ FLANGE x FEMALE COUPLER



PART #	QTY	PSI	PORT	DESCRIPTION	HANDLE
MVSD220FP	10 / Box	100	2"	2" FP Flange x 2" Female Coupler	VS25153
MVSD220HSFP	10 / Box	100	2"	2" FP Flange x 2" Female Coupler w SS Ball, Stem & Handle	VS20101SS
MVSD300FP	4 / Box	100	3"	3" Flange x 3" Female Coupler	V25153Y
MVSD300HSFP	4 / Box	100	3"	3" Flange x 3" Female Coupler w SS Ball, Stem & Handle	VS30101SS

### Valves feature:

- Compact Design
- Precision molded in polypropylene.
- Stainless Steel Bolts
- Polypropylene is reinforced with fiberglass for additional strength.
- Viton® "O" rings.
- Teflon® self-lubricating stem bushings and seats cannot stick or bind.

### Add'l features of VS Valve w SS Ball:

- Stainless Steel Ball, Handle, Stem and Bolts
- Locking Handle

## 3 WAY BOTTOM LOAD BALL VALVES



MV100BL



MV220BL



MV300BL

PART #	QTY	PSI	PIPE SIZE	OPENING THRU BALL	DESCRIPTION
MV100BL	1	150	1"	1"	1" Flange ; 3 Way Bottom Load Manifold
MV220BL	1	150	2"	2"	2" Flange ; 3 Way Bottom Load Manifold
MV300BL	1	150	3"	3"	3" Flange ; 3 Way Bottom Load Manifold

### Valves feature:

- Stainless Steel Bolts
- Viton® "O" rings.
- Precision molded in polypropylene.
- Polypropylene is reinforced with fiberglass for additional strength.
- Teflon® self-lubricating stem bushings and seats cannot stick or bind.
- Directional flow, right or left.
- Valve cannot be turned off to stop flow.

COMING EARLY 2024

## 3 WAY SIDE LOAD BALL VALVES



MV100SL



MV220SL

PART #	QTY	PSI	PIPE SIZE	OPENING THRU BALL	DESCRIPTION
MV100SL	1	150	1"	1"	1" Flange ; 3 Way Side Load Manifold
MV220SL	1	100	2"	2"	2" FP Flange ; 3 Way Side Load Manifold

### Valves feature:

- Stainless Steel Bolts
- Viton® "O" rings.
- Precision molded in polypropylene.
- Polypropylene is reinforced with fiberglass for additional strength.
- Teflon® self-lubricating stem bushings and seats cannot stick or bind.
- Directional flow, right or left.
- Valve cannot be turned off to stop flow.



## Sweep - Male NPT

PART #	QTY	DESCRIPTION
M220MPTSWP90	45 / Box	2" FP Flange x 2" Male NPT; 90°
M300MPTSWP90	20 / Box	3" FP Flange x 3" Male NPT; 90°

\*Gauge ports are not drilled or tapped. Located on both sides.



## Sweep

PART #	QTY	DESCRIPTION
M100SWP90	25 / Bag	1" Flange x 1" Flange
M220SWP90	55 / Box	2" FP Flange x 2" FP Flange
M300SWP90	20 / Box	3" Flange x 3" Flange

\*Gauge ports are not drilled or tapped. Located on both sides.



## Sweep - Hose Barb

PART #	QTY	DESCRIPTION
M100BRBSWP90	25 / Bag	1" Flange x 1" Hose Shank
M100125BRBSWP90	25 / Bag	1" Flange x 1-1/4" Hose Shank
M220BRBSWP90	40 / Box	2" FP Flange x 2" Hose Shank
M300BRBSWP90	12 / Box	3" Flange x 3" Hose Shank

\*Gauge ports are not drilled or tapped. Located on both sides.



## Hose Barb

PART #	QTY	DESCRIPTION
M100050BRB	25 / Bag	1" Flange x 1/2" Hose Barb
M100075BRB	25 / Bag	1" Flange x 3/4" Hose Barb
M100BRB	25 / Bag	1" Flange x 1" Hose Barb
M100125BRB	25 / Bag	1" Flange x 1-1/4" Hose Barb
M200100BRB	25 / Bag	2" Flange x 1" Hose Barb
M200125BRB	25 / Bag	2" Flange x 1-1/4" Hose Barb
M200150BRB	25 / Bag	2" Flange x 1-1/2" Hose Barb
M200BRB	25 / Bag	2" Flange x 2" Hose Barb
M220100BRB	25 / Bag	2" FP Flange x 1" Hose Barb
M220125BRB	25 / Bag	2" FP Flange x 1-1/4" Hose Barb
M220150BRB	25 / Bag	2" FP Flange x 1-1/2" Hose Barb
M220BRB	75 / Box	2" FP Flange x 2" Hose Barb
M300220BRB	50 / Box	3" Flange x 2" Hose Barb
M300BRB	21 / Box	3" Flange x 3" Hose Barb



## Coupling

PART #	PRICE ea.	QTY	DESCRIPTION
M100CPG		25 / Bag	1" Flange x 1" Flange
M220CPG		56 / Box	2" FP Flange x 2" FP Flange 2-31/32" Long
M300CPG		30 / Box	3" Flange x 3" Flange 4" Long

\*Gauge port is not drilled or tapped.



## Coupling Reducer

PART #	QTY	DESCRIPTION
M200100CPG	25 / Bag	2" Flange x 1" Reducer Flange
M220100CPG	25 / Bag	2" FP Flange x 1" Reducer Flange
M220200CPG	25 / Bag	2" FP Flange x 2" Reducer Flange
M300200CPG	54 / Box	3" Flange x 2" Reducer Flange
M300220CPG	54 / Box	3" Flange x 2" FP Reducer Flange



## 45° Coupling

PART #	QTY	DESCRIPTION
M220CPG45	55 / Box	2" FP Flange x 2" FP Flange
M300CPG45	25 / Box	3" Flange x 3" Flange



## Male NPT

PART #	QTY	DESCRIPTION
M100075MPT	25 / Bag	1" Flange x 3/4" Male NPT
M100MPT	25 / Bag	1" Flange x 1" Male NPT
M100125MPT	25 / Bag	1" Flange x 1-1/4" Male NPT
M200150MPT	25 / Bag	2" Flange x 1-1/2" Male NPT
M220MPT	85 / Box	2" FP Flange x 2" Male NPT
M300MPT	36 / Box	3" Flange x 3" Male NPT



## Plug

PART #	QTY	DESCRIPTION
M100PLG	25 / Bag	1" Flanged Plug
M220PLG	250 / Box	2" FP Flanged Plug
M300PLG	150 / Box	3" Flanged Plug



## Male Adapter

PART #	QTY	DESCRIPTION
M100A	25 / Bag	1" Flange x 1" Male Adapter
M220A	90 / Box	2" FP Flange x 2" Male Adapter
M300A	54 / Box	3" Flange x 3" Male Adapter



## Female Coupler

PART #	DESCRIPTION
M220D	2" FP Flange x 2" Female Coupler
M300D	3" Flange x 3" Female Coupler



## Hose Barb Tee

PART #	DESCRIPTION
M220200HBT	2" FP Flange x 2" Hose Barb Tee
M220300HBT	2" FP Flange x 3" Hose Barb Tee
M300300HBT	3" Flange x 3" Hose Barb Tee



## Cross

PART #	QTY	DESCRIPTION
M100CR	25 / Bag	1" Flanged Cross
M220CR	20 / Box	2" FP Flanged Cross
M300CR	8 / Box	3" Flanged Cross

\*Gauge port is not drilled or tapped.



## Female NPT

PART #	QTY	DESCRIPTION
M100050FPT	25 / Bag	1" Flange x 1/2" Female NPT
M100075FPT	25 / Bag	1" Flange x 3/4" Female NPT
M100FPT	25 / Bag	1" Flange x 1" Female NPT
M220FPT	75 / Box	2" FP Flange x 2" Female NPT
M300FPT	45 / Box	3" Flange x 3" Female NPT



## TEE

PART #	QTY	DESCRIPTION
M100TEE	25 / Bag	1" Flanged Tee
M220TEE	24 / Box	2" FP Flanged Tee
M300TEE	8 / Box	3" Flanged Tee

\*Gauge port is not drilled or tapped.



**MTF220**



### Manifold Bulkhead Fitting

Glass Reinforced Polypropylene  
EDPM standard

PART #	QTY	THREAD	WASHER	HOLE SIZE
<b>INTERNAL SEALING</b>				
<b>POLY</b>				
MTF220	300 / Box	2" FP Flange x 2" Female NPT	EPDM	3-1/4"
MTF220V	30 / Box	2" FP Flange x 2" Female NPT	VITON	3-1/4"
MTF300	8 / Box	3" Flange x 3" Female NPT	EPDM	4-1/2"
MTF300V	8 / Box	3" Flange x 3" Female NPT	VITON	4-1/2"



**NEW**



LS15050

## MANIFOLD FLANGE T STRAINER

- Heavy Duty Glass Reinforced Polypropylene
- Clean Out Plug
- EPDM Gaskets; Viton® available
- Replacement parts available (see below)

PART #	DESCRIPTION
MLST10030	1" Female NPT; Manifold T Strainer; 30 Mesh SS Screen
MLST10050	1" Female NPT; Manifold T Strainer; 50 Mesh SS Screen
MLST10080	1" Female NPT; Manifold T Strainer; 80 Mesh SS Screen
MLST100100	1" Female NPT; Manifold T Strainer; 100 Mesh SS Screen
MLST15030	2" Female NPT; Manifold T Strainer; 30 Mesh SS Screen
MLST15050	2" Female NPT; Manifold T Strainer; 50 Mesh SS Screen
MLST15080	2" Female NPT; Manifold T Strainer; 80 Mesh SS Screen
MLST150100	2" Female NPT; Manifold T Strainer; 100 Mesh SS Screen

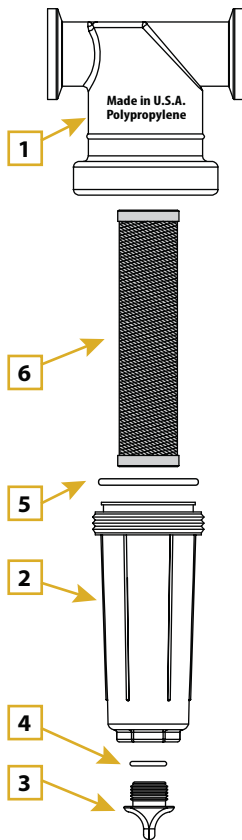

## Replacement Parts for: 1" & 2" MANIFOLD FLANGE T STRAINER

ITEM	PART #	DESCRIPTION
1	MLST100H	1" T Strainer Body
1	MLST150H	1-1/2" T Strainer Body
2	LST100B	1" T Bowl (contains #1, #2, #3, #4)
2	LST150B	1-1/2" T Bowl (contains #1, #2, #3, #4)
3	LSP050	1/2" Clean Out Plug
3	LSP100	1" Clean Out Plug
4	LSP050G	EPDM O-Ring for 1/2" Clean Out Plug
4	LSP050GV	Viton® O-Ring for 1/2" Clean Out Plug
4	LSP100G	EPDM O-Ring for 1" Clean Out Plug
4	LSP100GV	Viton® O-Ring for 1" Clean Out Plug
5	LST100G	1" O-Ring ; EPDM
5	LST100GV	1" O-Ring ; Viton®
5	LST150G	1-1/2" O-Ring ; EPDM
5	LST150GV	1-1/2" O-Ring ; Viton®
6	LST130SS	30 Mesh for 1" T Strainers; 316SS
6	LST1530SS	30 Mesh for 1-1/2" T Strainers; 316SS
6	LST150SS	50 Mesh for 1" T Strainers; 316SS
6	LST1550SS	50 Mesh for 1-1/2" T Strainers; 316SS
6	LST180SS	80 Mesh for 1" T Strainers; 316SS
6	LST1580SS	80 Mesh for 1-1/2" T Strainers; 316SS
6	LST1100SS	100 Mesh for 1" T Strainers; 316SS
6	LST15100SS	100 Mesh for 1-1/2" T Strainers; 316SS
KIT	MLST100HB	1" Manifold T Strainer Kit includes 1-5
KIT	MLST150HB	1-1/2" Manifold T Strainer Kit includes 1-5



**NEW**



MLS20020



MLS22020

## 2" MANIFOLD FLANGE Y STRAINER

- Heavy Duty Glass Reinforced Polypropylene
- Clean Out Plug
- EPDM Gaskets; Viton® available
- Replacement parts available (see below)

PART #	DESCRIPTION
MLS20012	2" Standard Port Manifold Y Strainer; 12 Mesh SS Screen
MLS20020	2" Standard Port Manifold Y Strainer; 20 Mesh SS Screen
MLS20030	2" Standard Port Manifold Y Strainer; 30 Mesh SS Screen
MLS20050	2" Standard Port Manifold Y Strainer; 50 Mesh SS Screen
MLS20080	2" Standard Port Manifold Y Strainer; 80 Mesh SS Screen
MLS22012	2" Full Port Manifold Y Strainer; 12 Mesh SS Screen
MLS22020	2" Full Port Manifold Y Strainer; 20 Mesh SS Screen
MLS22030	2" Full Port Manifold Y Strainer; 30 Mesh SS Screen
MLS22050	2" Full Port Manifold Y Strainer; 50 Mesh SS Screen
MLS22080	2" Full Port Manifold Y Strainer; 80 Mesh SS Screen

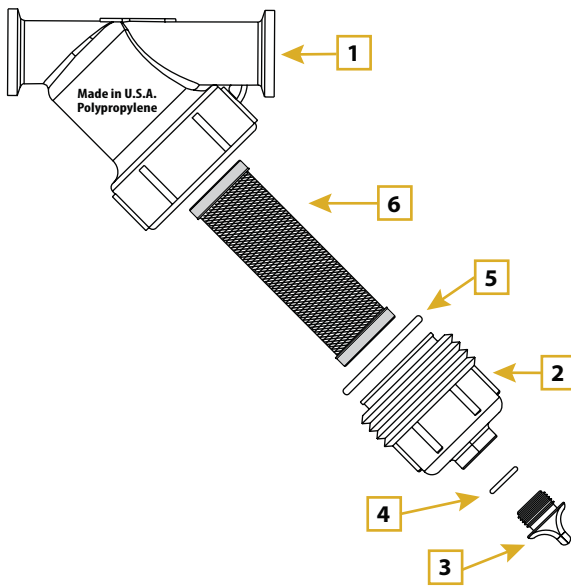

## Replacement Parts for: 2" MANIFOLD FLANGE Y STRAINER

ITEM	PART #	DESCRIPTION
1	MLS200B	2" Y Strainer Body
1	MLS220B	2" FP Y Strainer Body
2	LS150C	2" End Cap (contains #1, #2, #3, #4)
3	LSP100	1" Clean Out Plug
4	LSP100G	EPDM O-Ring for 1-1/2" & 2" Clean Out Plug
4	LSP100GV	VITON® O-Ring for 1-1/2" & 2" Clean Out Plug
5	LS150G	2" O-Ring ; EPDM
5	LS150GV	2" O-Ring ; VITON®
6	LS212SS	12 Mesh for 2" Y Strainers; 316SS
6	LS220SS	20 Mesh for 2" Y Strainers; 316SS
6	LS230SS	30 Mesh for 2" Y Strainers; 316SS
6	LS250SS	50 Mesh for 2" Y Strainers; 316SS
6	LS280SS	80 Mesh for 2" Strainers; 316SS
KIT	MLS200BC	2" Manifold Y Strainer Kit includes 1-5
KIT	MLS220BC	2" FP Manifold Y Strainer Kit includes 1-5



## T BOLT FLANGE CLAMPS



PART #	QTY	TORQUE	BAND WIDTH	DESCRIPTION
FC220TB	10	120	3/4"	2" FP T-Bolt Flange Clamp; Stainless Steel
FC300TB	10	120	3/4"	3" T-Bolt Flange Clamp; Stainless Steel

## HINGE CASTED CLAMPS



PART #	QTY	TORQUE	DESCRIPTION
FC220HC	10	150	2" FP Hinge Flange Clamp; Stainless Steel
FC300HC	10	150	3" FP Hinge Flange Clamp; Stainless Steel





## SMART-Seal™ FLANGE GASKETS



PART #	QTY	COLOR	MATERIAL	DESCRIPTION
FG100	50 / Bag	Black	EPDM	1" Flange Gasket
FG200	50 / Bag	Black	EPDM	2" Flange Gasket
FG220	50 / Bag	Black	EPDM	2" FP Flange Gasket
FG300	50 / Bag	Black	EPDM	3" Flange Gasket
FG100V	50 / Bag	Green	Viton®	1" Flange Gasket
FG200V	50 / Bag	Green	Viton®	2" Flange Gasket
FG220V	50 / Bag	Green	Viton®	2" FP Flange Gasket
FG300V	50 / Bag	Green	Viton®	3" Flange Gasket

## FLANGE CLAMPS



PART #	QTY	TORQUE	BAND WIDTH	DESCRIPTION
FC100	50 / Box	100	9/16"	1" Flange Clamp; Stainless Steel
FC200	50 / Box	100	9/16"	2" Flange Clamp; Stainless Steel
FC220	50 / Box	100	9/16"	2" FP Flange Clamp; Stainless Steel
FC300	50 / Box	100	9/16"	3" Flange Clamp; Stainless Steel

### Clamps feature:

- 300 Series Stainless Steel
- Band Width 9/16"
- Band Thickness .028
- Shipped at Maximum Diameter

# Cam Lever Couplings



## **SAFETY** **CAMLOCK**

*After market research and study by the TerreMax team, an innovative solution was birthed to help enhance the product. The Safety Camlock coupling was designed and patented to provide a market solution.*

### **Safety**

*The Safety Camlock was designed to provide enhanced safety with the exclusive cam lever locking mechanism. This mechanism helps reduce the possibility of unintentional opening of the cam levers during use, which could result in personal injury and costly spills.*

## **CAMLOCK**

### **Interchangeability**

*The CamLock series couplers are made to an industry standard and will interchange with all cam lever coupler brands & materials made to the universal specification.*

### **Quality**

*TerreMax is an ISO 9001 certified company. Safety Camlock & CamLock couplers are manufactured at our Indiana facility to the highest quality standard in the industry.*



# SAFETY CAMLOCK COUPLINGS



## B Series

PART #	QTY	DESCRIPTION
SAF050B	25 / Bag	3/4" Female Coupler x 1/2" Male NPT
SAF075B	25 / Bag	3/4" Female Coupler x 3/4" Male NPT
SAF100B	25 / Bag	1" Female Coupler x 1" Male NPT
SAF125B	25 / Bag	1" Female Coupler x 1-1/4" Male NPT
SAF150B	40 / Box	1-1/2" Female Coupler x 1-1/2" Male NPT
SAF200B	28 / Box	2" Female Coupler x 2" Male NPT
SAF300B	15 / box	3" Female Coupler x 3" Male NPT



## C Series

PART #	QTY	DESCRIPTION
SAF050C	25 / Bag	3/4" Female Coupler x 1/2" Hose Barb
SAF075C	25 / Bag	3/4" Female Coupler x 3/4" Hose Barb
SAF100C	25 / Bag	1" Female Coupler x 1" Hose Barb
SAF125C	25 / Bag	1" Female Coupler x 1-1/4" Hose Barb
SAF150C	35 / Box	1-1/2" Female Coupler x 1-1/2" Hose Barb
SAF200C	28 / Box	2" Female Coupler x 2" Hose Barb
SAF300C	15 / Box	3" Female Coupler x 3" Hose Barb



## D Series

PART #	QTY	DESCRIPTION
SAF050D	25 / Bag	3/4" Female Coupler x 1/2" Female NPT
SAF075D	25 / Bag	3/4" Female Coupler x 3/4" Female NPT
SAF100D	25 / Bag	1" Female Coupler x 1" Female NPT
SAF125D	25 / Bag	1" Female Coupler x 1-1/4" Female NPT
SAF150D	32 / Box	1-1/2" Female Coupler x 1-1/2" Female NPT
SAF200D	28 / Box	2" Female Coupler x 2" Female NPT
SAF300D	30 / Box	3" Female Coupler x 3" Female NPT



## CAP Series

PART #	QTY	DESCRIPTION
SAF075CAP	25 / Bag	3/4" CAP for Male Adapter
SAF100125CAP	25 / Bag	1" CAP for Male Adapter
SAF150CAP	64 / Box	1-1/2" CAP for Male Adapter
SAF200CAP	28 / Box	2" CAP for Male Adapter
SAF300CAP	30 / Box	3" CAP for Male Adapter

### Safety Camlock Coupling features:

- Patented Locking Arms to reduce possibility of unintentional opening of cam levers during use.
- Glass Filled Polypropylene
- 1/2" thru 2" Maximum Operating Pressure 125 psi @ 70°F.
- 3" Maximum Operating Pressure 75 psi @ 70°F.
- E.P.D.M. Gaskets

1/2"series couplings interchange with 3/4" size couplings. Coupling ends are 3/4" size.  
 1-1/4"series couplings interchange with 1" size couplings. Coupling ends are 1" size.





## A Series

PART #	QTY	DESCRIPTION
050A	25 / Bag	3/4" Male Adapter x 1/2" Female NPT
075A	25 / Bag	3/4" Male Adapter x 3/4" Female NPT
100A	25 / Bag	1" Male Adapter x 1" Female NPT
125A	25 / Bag	1" Male Adapter x 1-1/4" Female NPT
150125A		1-1/2" Male Adapter x 1-1/4" Female NPT
150A	115 / Box	1-1/2" Male Adapter x 1-1/2" Female NPT
200A	72 / Box	2" Male Adapter x 2" Female NPT
300A	36 / Box	3" Male Adapter x 3" Female NPT
400A		4" Male Adapter x 3" Female NPT



## B Series

PART #	QTY	DESCRIPTION
050B	25 / Bag	3/4" Female Coupler x 1/2" Male NPT
075B	25 / Bag	3/4" Female Coupler x 3/4" Male NPT
100B	25 / Bag	1" Female Coupler x 1" Male NPT
125B	25 / Bag	1" Female Coupler x 1-1/4" Male NPT
150125B		1-1/2" Female Coupler x 1-1/4" Male NPT
150B	40 / Box	1-1/2" Female Coupler x 1-1/2" Male NPT
200B	28 / Box	2" Female Coupler x 2" Male NPT
300B	15 / Box	3" Female Coupler x 3" Male NPT
400B		4" Female Coupler x 4" Male NPT



## C Series

PART #	QTY	DESCRIPTION
050C	25 / Bag	3/4" Female Coupler x 1/2" Hose Barb
075C	25 / Bag	3/4" Female Coupler x 3/4" Hose Barb
100C	25 / Bag	1" Female Coupler x 1" Hose Barb
125C	25 / Bag	1" Female Coupler x 1-1/4" Hose Barb
150125C		1-1/2" Female Coupler x 1-1/4" Hose Barb
150C	36 / Box	1-1/2" Female Coupler x 1-1/2" Hose Barb
200150C		2" Female Coupler x 1-1/2" Hose Barb
200C	28 / Box	2" Female Coupler x 2" Hose Barb
300C	15 / Box	3" Female Coupler x 3" Hose Barb
400C		4" Female Coupler x 4" Hose Barb

**NEW**

### Cam Lever Coupling features:

- Glass Filled Polypropylene
- 1/2" thru 2" Maximum Operating Pressure 125 psi @ 70°F.
- 3" and 4" Maximum Operating Pressure 75 psi @ 70°F.
- E.P.D.M. Gaskets



## D Series

PART #	QTY	DESCRIPTION
050D	25 / Bag	3/4" Female Coupler x 1/2" Female NPT
075D	25 / Bag	3/4" Female Coupler x 3/4" Female NPT
100D	25 / Bag	1" Female Coupler x 1" Female NPT
125D	25 / Bag	1" Female Coupler x 1-1/4" Female NPT
150125D		1-1/2" Female Coupler x 1-1/4" Female NPT
150D	32 / Box	1-1/2" Female Coupler x 1-1/2" Female NPT
200D	28 / Box	2" Female Coupler x 2" Female NPT
300D	30 / Box	3" Female Coupler x 3" Female NPT
400D		4" Female Coupler x 4" Female NPT

1/2" series couplings interchange with 3/4" size couplings. Coupling ends are 3/4" size.

1-1/4" series couplings interchange with 1" size couplings. Coupling ends are 1" size.

4" Camlocks have 3 arms

- Product may vary depending on size.



## E Series

PART #	QTY	DESCRIPTION
050E	25 / Bag	3/4" Male Adapter x 1/2" Hose Barb
075E	25 / Bag	3/4" Male Adapter x 3/4" Hose Barb
100E	25 / Bag	1" Male Adapter x 1" Hose Barb
125E	25 / Bag	1" Male Adapter x 1-1/4" Hose Barb
150125E		1-1/2" Male Adapter x 1-1/4" Hose Barb
150E	95 / Box	1-1/2" Male Adapter x 1-1/2" Hose Barb
200E	70 / Box	2" Male Adapter x 2" Hose Barb
300E	21 / Box	3" Male Adapter x 3" Hose Barb
400E		4" Male Adapter x 4" Hose Barb



## CAP Series

PART #	QTY	DESCRIPTION
050075CAP	25 / Bag	3/4" CAP for Male Adapter
100125CAP	25 / Bag	1" CAP for Male Adapter
150CAP	64 / Box	1-1/2" CAP for Male Adapter
200CAP	28 / Box	2" CAP for Male Adapter
300CAP	30 / Box	3" CAP for Male Adapter
400CAP		4" CAP for Male Adapter

### Cam Lever Coupling features:

- Glass Filled Polypropylene
- 1/2" thru 2" Maximum Operating Pressure 125 psi @ 70°F.
- 3" and 4" Maximum Operating Pressure 75 psi @ 70°F.
- E.P.D.M. Gaskets

1/2"series couplings interchange with 3/4" size couplings. Coupling ends are 3/4" size.

1-1/4"series couplings interchange with 1" size couplings. Coupling ends are 1" size.

4" Camlocks have 3 arms

- Product may vary depending on size.



## F Series

PART #	QTY	DESCRIPTION
050F	25 / Bag	3/4" Male Adapter x 1/2" Male NPT
075F	25 / Bag	3/4" Male Adapter x 3/4" Male NPT
100F	25 / Bag	1" Male Adapter x 1" Male NPT
125F	25 / Bag	1" Male Adapter x 1-1/4" Male NPT
150125F		1-1/2" Male Adapter x 1-1/4" Male NPT
150F	120 / Box	1-1/2" Male Adapter x 1-1/2" Male NPT
200F	80 / Box	2" Male Adapter x 2" Male NPT
300F	18 / Box	3" Male Adapter x 3" Male NPT
400F		4" Male Adapter x 4" Male NPT



## PL Series

PART #	QTY	DESCRIPTION
050075PL	25 / Bag	3/4" Plug for Female Coupler
100125PL	25 / Bag	1" Plug for Female Coupler
150PL	25 / Box	1-1/2" Plug for Female Coupler
200PL	96 / Box	2" Plug for Female Coupler
300PL	65 / Box	3" Plug for Female Coupler
400PL		4" Plug for Female Coupler



## Plug with Handle\*

\*Sold under License, US Patent Nos. 7,644,734 and 8,397,764

PART #	QTY	DESCRIPTION
200PLH	50 / Box	2" Plug with Handle
300PLH	24 / Box	3" Plug with Handle

# CAMLOCK COUPLINGS



## 2" x 3" Series

PART #	QTY	DESCRIPTION
300200F		2" Male Adapter x 3" Male NPT
300200A		2" Male Adapter x 3" Female NPT
300B200A	15 / Box	3" Female Coupler x 2" Male Adapter
300200D	15 / Box	3" Female Coupler x 2" Female NPT
SAF300B200A	15 / Box	3" Female Coupler x 2" Male Adapter
SAF300200D	15 / Box	3" Female Coupler x 2" Female NPT

## Plug with Handle\*



PART #	QTY	DESCRIPTION
200PLH	50 / Box	2" Plug with Handle
300PLH	24 / Box	3" Plug with Handle

\*Sold under License, US Patent Nos. 7,644,734 and 8,397,764



## Replacement Gasket

PART #	DESCRIPTION
75G	1/2" & 3/4" EPDM Gasket
100G	1" & 1-1/4" EPDM Gasket
150G	1-1/2" EPDM Gasket
200G	2" EPDM Gasket
300G	3" EPDM Gasket
400G	4" EPDM Gasket
75GV	3/4" Viton® Gasket
100GV	1" Viton® Gasket
150GV	1-1/2" Viton® Gasket
200GV	2" Viton® Gasket
300GV	3" Viton® Gasket
75GXT	3/4" Xtra Thick Gasket
100GXT	1" Xtra Thick Gasket
150GXT	1-1/2" Xtra Thick Gasket
200GXT	2" Xtra Thick Gasket
300GXT	3" Xtra Thick Gasket



## Garden Hose Couplings

Polypropylene Garden Hose Couplings used to connect a Female GHT to a Male GHT

PART #	SIZE & DESCRIPTION
GLP075AG	3/4" Female GHT x 3/4" Male Adapter
GLP075BG	3/4" Male GHT x 3/4" Female Coupler
GLP075DG	3/4" Female GHT x 3/4" Female Coupler
GLP075FG	3/4" Male GHT x 3/4" Male Adapter

Use either of the valve connectors as a quick shutoff at the end of any garden hose.

## Camlock Shims



PART #	DESCRIPTION
SHIM075	3/4" Gasket Shim
SHIM100	1" Gasket Shim
SHIM150	1-1/2" Gasket Shim
SHIM200	2" Gasket Shim
SHIM300	3" Gasket Shim
SHIM400	4" Gasket Shim



## SWEEP 90°

- Improves Fluid Flow
- Reduces back pressure on pump seal

PART #	DESCRIPTION
200CSWP90	2" Female Coupler x 2" Hose Barb Sweep

\*Gauge ports are not drilled or tapped.



## SWEEP 90°

- Improves Fluid Flow
- Reduces back pressure on pump seal

PART #	QTY	DESCRIPTION
200FSWP90	35 / Box	2" Male Adapter x 2" Male NPT ; 90°
300FSWP90	14 / Box	3" Male Adapter x 3" Male NPT ; 90°



**AL**  
90° Series



**CL**  
90° Series



**DL**  
90° Series



**FL**  
90° Series



**Spool**  
Adapter



**45° F**  
Series

## 90 Degree Coupling features:

- Glass Filled Polypropylene
- Maximum Operating Pressure 125 P.S.I. @ 70°F
- E.P.D.M. Gaskets

PART #	DESCRIPTION
150A90	1-1/2" Male Adapter x 1-1/2" Female NPT
200A90	2" Male Adapter x 2" Female NPT
150C90	1-1/2" Female Coupler x 1-1/2" Hose Shank
200C90	2" Female Coupler x 2" Hose Shank
150D90	1-1/2" Female Coupler x 1-1/2" Female NPT
200D90	2" Female Coupler x 2" Female NPT
150F90	1-1/2" Male Adapter x 1-1/2" Male NPT
200F90	2" Male Adapter x 2" Male NPT
200FF	2" Male Adapter x 2" Male Adapter
200F45	2" Male Adapter x 2" Male NPT



## Hose Clamps

- Worm Gear - 67 Series 1/2" Hy Gear Band
- Screw - 5/16" Hex Head; 410 Stainless Steel
- Housing - 200 Stainless Steel
- Band - 1/2"; 200 Stainless Steel
- Installation Torque - 35 in/lbs (4Nm)

HOSE CLAMPS	
PART #	DIAMETER RANGE (inches) /Size
K62604	.250 - .625 / Size 4 micro
K62606	.312 - .875 / Size 6 micro
K6706-1	.375 - .875 / Size 6
K6708-1	.437 - 1.00 / Size 8
K6710-1	.500 - 1.06 / Size 10
K6712-1	.500 - 1.25 / Size 12
K6716-1	.687 - 1.50 / Size 16
K6720-1	.750 - 1.75 / Size 20
K6724-1	1.00 - 2.00 / Size 24
K6728-1	1.25 - 2.25 / Size 28
K6732-1	1.50 - 2.50 / Size 32
K6736-1	.750 - 2.75 / Size 36
K6740-1	1.00 - 3.00 / Size 40
K6744-1	1.25 - 3.25 / Size 44
K6748-1	1.50 - 3.50 / Size 48
K6756-1	2.00 - 4.00 / Size 56
K6764-1	2.50 - 4.50 / Size 64
K6780-1	3.50 - 5.50 / Size 80
K6796-1	4.50 - 6.50 / Size 96
K67104	5.00 - 7.00 / Size 104

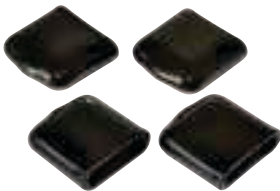

## Skin Savers

SKIN SAVERS	
PART #	DESCRIPTION
KSS500.50	Skin Saver; 1/2" band width
KSS562.50	Skin Saver; 9/16" band width
KSS625.50	Skin Saver; 5/8" band width



## Pressure Seal HD Clamps

- 5/8" Band Width
- 300 Stainless Steel construction
- 150 in/lbs ultimate torque
- Spring compression of liner creates 360° pressure on hose
- Trough feature exerts additional pressure on hose



### PRESSURE SEAL HD CLAMPS

PART #	DIAMETER RANGE (inches)
PC12	range .81" - 1.04" for 1/2" hose
PC14	range .88" - 1.17" for 3/4" hose
PC16	range 1.13" - 1.45" for 1" hose
PC20	range 1.13" - 1.56" for 1" hose
PC24	range 1.50" - 1.82" for 1-1/4" hose
Pc28	range 1.55" - 2.25"
PC238	range 1.62" - 2.12" for 1-1/2" hose
PC262	range 1.88" - 2.37"
PC275	range 2.00" - 2.50" for 2" hose
PC288	range 2.12" - 2.62" for 2" hose
PC300	range 2.25" - 2.75"
PC325	range 2.50" - 3.00"
PC350	range 2.75" - 3.25"
PC375	range 2.88" - 3.50"
PC400	range 3.12" - 3.75" for 3" hose
PC425	range 3.31" - 4.00"
PC450	range 3.44" - 4.25"
PC512	range 4.06" - 4.87" for 4" hose

## T Bolt Clamps

- Heavy Duty - 300 Series T-Bolt
- 90 in/lbs torque
- T-Bolt - 1/4" 300 Stainless Steel
- Hex Nut - 7/16" 300 Stainless Steel w/Nylon Insert
- Band - 3/4" or 7/8" 300 Stainless Steel
- Bridge - 3/4" 300 Stainless Steel
- Trunnion - 300 Stainless Steel



### T BOLT CLAMPS

PART #	DIAMETER RANGE (inches) / Size
TC120	1.20 - 1.34 / Size 120
TC130	1.30 - 1.50 / Size 130
TC150	1.50 - 1.76 / Size 150
TC162	1.62 - 1.87 / Size 162
TC181	1.81 - 2.06 / Size 181
TC193	1.93 - 2.18 / Size 218
TC206	2.06 - 2.40 / Size 206
TC218	2.18 - 2.50 / Size 218
TC224	2.24 - 2.55 / Size 224
TC231	2.31 - 2.69 / Size 231
TC250	2.50 - 2.81 / Size 250
TC287	2.87 - 3.18 / Size 287
TC312	3.12 - 3.49 / Size 312
TC331	3.31 - 3.62 / Size 331
TC343	3.43 - 3.81 / Size 343
TC425	4.25 - 4.56 / Size 425
TC438	4.38 - 4.76 / Size 438
TC456	4.56 - 4.94 / Size 456

# Strainers

**FEATURED ITEMS —**

**Threaded  
& Manifold  
T Strainers**



**Threaded  
& Manifold Y Strainers**



## ***Selection***

These heavy duty fittings are available in sizes ranging from 1/2" to 2".

## ***Durability***

TerreMax's fittings are utilized for a variety of agricultural, plumbing and industrial liquid-handling solutions.

## ***Polypropylene***

Our resin is a high-strength, custom blended, glass-filled polypropylene.

## ***Knowledge***

Let us use our expertise to help you make the right choice.

## ***Experience***

We have been producing high quality fittings for over 4 decades.



**NEW**



LST10050

**FEMALE THREADED T STRAINER**

- Heavy Duty Glass Reinforced Polypropylene
- Clean Out Plug
- EPDM Gaskets; Viton® available
- Replacement parts available (see below)

PART #	DESCRIPTION
LST07530	3/4" Female NPT; T Strainer; 30 Mesh SS Screen
LST07550	3/4" Female NPT; T Strainer; 50 Mesh SS Screen
LST07580	3/4" Female NPT; T Strainer; 80 Mesh SS Screen
LST075100	3/4" Female NPT; T Strainer; 100 Mesh SS Screen
LST10030	1" Female NPT; T Strainer; 30 Mesh SS Screen
LST10050	1" Female NPT; T Strainer; 50 Mesh SS Screen
LST10080	1" Female NPT; T Strainer; 80 Mesh SS Screen
LST100100	1" Female NPT; T Strainer; 100 Mesh SS Screen
LST12530	1-1/4" Female NPT; T Strainer; 30 Mesh SS Screen
LST12550	1-1/4" Female NPT; T Strainer; 50 Mesh SS Screen
LST12580	1-1/4" Female NPT; T Strainer; 80 Mesh SS Screen
LST125100	1-1/4" Female NPT; T Strainer; 100 Mesh SS Screen
LST15030	1-1/2" Female NPT; T Strainer; 30 Mesh SS Screen
LST15050	1-1/2" Female NPT; T Strainer; 50 Mesh SS Screen
LST15080	1-1/2" Female NPT; T Strainer; 80 Mesh SS Screen
LST150100	1-1/2" Female NPT; T Strainer; 100 Mesh SS Screen

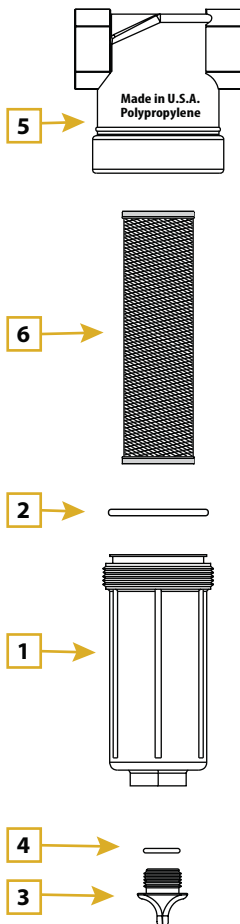

**Replacement Parts for:  
FEMALE THREADED T STRAINER**

ITEM	PART #	DESCRIPTION
1	LST100B	3/4" & 1" Bowl (contains #1, #2, #3, #4)
1	LST150B	1-1/4" & 1-1/2" Bowl (contains #1, #2, #3, #4)
2	LST100G	3/4" & 1" O-Ring ; EPDM
2	LST150G	1-1/4" & 1-1/2" O-Ring ; EPDM
2	LST100GV	3/4" & 1" O-Ring ; VITON®
2	LST150GV	1-1/4" & 1-1/2" O-Ring ; VITON®
3	LSP050	1/2" Clean Out Plug
3	LSP100	1" Clean Out Plug
4	LSP050G	EPDM O-Ring for 1/2" Clean Out Plug
4	LSP050GV	Viton® O-Ring for 1/2" Clean Out Plug
4	LSP100G	EPDM O-Ring for 1" Clean Out Plug
4	LSP100GV	Viton® O-Ring for 1" Clean Out Plug
6	LST130SS	30 Mesh for 3/4" & 1" T Strainers; 316SS
6	LST1530SS	30 Mesh for 1-1/4" & 1-1/2" T Strainers; 316SS
6	LST150SS	50 Mesh for 3/4" & 1" T Strainers; 316SS
6	LST1550SS	50 Mesh for 1-1/4" & 1-1/2" T Strainers; 316SS
6	LST180SS	80 Mesh for 3/4" & 1" T Strainers; 316SS
6	LST1580SS	80 Mesh for 1-1/4" & 1-1/2" T Strainer; 316SS
6	LST1100SS	100 Mesh for 3/4" & 1" T Strainers; 316SS
6	LST15100SS	100 Mesh for 1-1/4" & 1-1/2" T Strainers; 316SS
5	LST075H	3/4" Female NPT; T Strainer Head
5	LST100H	1" Female NPT; T Strainer Head
5	LST125H	1-1/4" Female NPT; T Strainer Head
5	LST150H	1-1/2" Female NPT; T Strainer Head
N/S	LST075HB	3/4" T Strainer Kit includes 1-5
N/S	LST100HB	1" T Strainer Kit includes 1-5
N/S	LST125HB	1-1/4" T Strainer Kit includes 1-5
N/S	LST150HB	1-1/2" T Strainer Kit includes 1-5

**NEW**



LS12580

## 1/2" — 1-1/4" FEMALE THREADED Y STRAINER

- Heavy Duty Glass Reinforced Polypropylene
- Clean Out Plug
- EPDM Gaskets; Viton® available
- Replacement parts available (see below)

PART #	DESCRIPTION
LS05020	1/2" Female NPT; Y Strainer; 20 Mesh SS Screen
LS05040	1/2" Female NPT; Y Strainer; 40 Mesh SS Screen
LS05080	1/2" Female NPT; Y Strainer; 80 Mesh SS Screen
LS07520	3/4" Female NPT; Y Strainer; 20 Mesh SS Screen
LS07540	3/4" Female NPT; Y Strainer; 40 Mesh SS Screen
LS07580	3/4" Female NPT; Y Strainer; 80 Mesh SS Screen
LS10020	1" Female NPT; Y Strainer; 20 Mesh SS Screen
LS10040	1" Female NPT; Y Strainer; 40 Mesh SS Screen
LS10080	1" Female NPT; Y Strainer; 80 Mesh SS Screen
LS12520	1-1/4" Female NPT; Y Strainer; 20 Mesh SS Screen
LS12540	1-1/4" Female NPT; Y Strainer; 40 Mesh SS Screen
LS12580	1-1/4" Female NPT; Y Strainer; 80 Mesh SS Screen

\*No Clean Out Port on 1/2" or 3/4" cap; LS075C

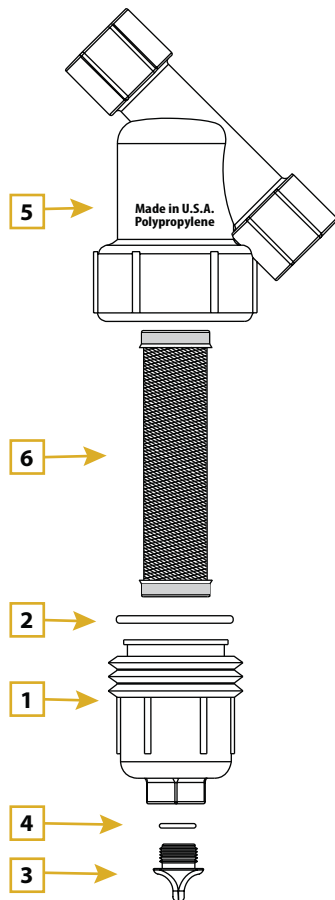

## Replacement Parts for: 1/2" — 1-1/4" FEMALE THREADED Y STRAINER

ITEM	PART #	DESCRIPTION
1	LS075C	1/2" & 3/4" End Cap (contains #1, #2, #3, #4)
1	LS100C	1" & 1-1/4" End Cap (contains #1, #2, #3, #4)
2	LS075G	1/2" & 3/4" O-Ring; EPDM
2	LS075GV	1/2" & 3/4" O-Ring; VITON®
2	LS100G	1" & 1-1/4" O-Ring; EPDM
2	LS100GV	1" & 1-1/4" O-Ring; VITON®
3	LSP050	1/2" Clean Out Plug (fits 1" & 1-1/4")
4	LSP050G	EPDM O-Ring for 1/2" Clean Out Plug
4	LSP050GV	VITON® O-Ring for 1/2" Clean Out Plug
6	LS720SS	20 Mesh for 1/2" & 3/4" Y Strainers; 316SS
6	LS120SS	20 Mesh for 1" & 1-1/4" Y Strainers; 316SS
6	LS740SS	40 Mesh for 1/2" & 3/4" Y Strainers; 316SS
6	LS140SS	40 Mesh for 1" & 1-1/4" Y Strainers; 316SS
6	LS780SS	80 Mesh for 1/2" & 3/4" Y Strainers; 316SS
6	LS180SS	80 Mesh for 1" & 1-1/4" Y Strainers; 316SS
5	LS050B	1/2" Female NPT; Y Strainer Body
5	LS075B	3/4" Female NPT; Y Strainer Body
5	LS100B	1" Female NPT; Y Strainer Body
5	LS125B	1-1/4" Female NPT; Y Strainer Body
N/S	LS050BC	1/2" Y Strainer Kit includes 1-5
N/S	LS075BC	3/4" Y Strainer Kit includes 1-5
N/S	LS100BC	1" Y Strainer Kit includes 1-5
N/S	LS125BC	1-1/4" Y Strainer Kit includes 1-5



**NEW**



LS20050

## 1-1/2" & 2" FEMALE THREADED Y STRAINER

- Heavy Duty Glass Reinforced Polypropylene
- Clean Out Plug
- EPDM Gaskets; Viton® available
- Replacement parts available (see below)

PART #	DESCRIPTION
LS15012	1-1/2" Female NPT; Y Strainer; 12 Mesh SS Screen
LS15020	1-1/2" Female NPT; Y Strainer; 20 Mesh SS Screen
LS15030	1-1/2" Female NPT; Y Strainer; 30 Mesh SS Screen
LS15050	1-1/2" Female NPT; Y Strainer; 50 Mesh SS Screen
LS15080	1-1/2" Female NPT; Y Strainer; 80 Mesh SS Screen
LS20012	2" Female NPT; Y Strainer; 12 Mesh SS Screen
LS20020	2" Female NPT; Y Strainer; 20 Mesh SS Screen
LS20030	2" Female NPT; Y Strainer; 30 Mesh SS Screen
LS20050	2" Female NPT; Y Strainer; 50 Mesh SS Screen
LS20080	2" Female NPT; Y Strainer; 80 Mesh SS Screen

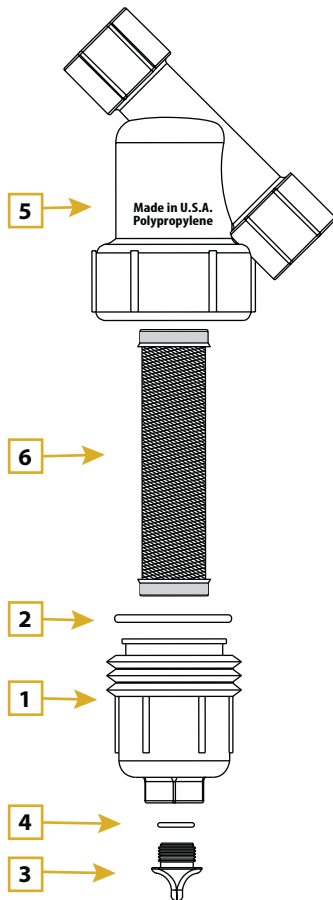

## Replacement Parts for: 1-1/2" & 2" FEMALE THREADED Y STRAINER

ITEM	PART #	DESCRIPTION
1	LS150C	1-1/2" & 2" End Cap (contains #1, #2, #3, #4)
2	LS150G	1-1/2" & 2" O-Ring ; EPDM
2	LS150GV	1-1/2" & 2" O-Ring ; VITON®
3	LSP100	1" Clean Out Plug (fits 1-1/2" & 2")
4	LSP100G	EPDM O-Ring for 1-1/2" & 2" Clean Out Plug
4	LSP100GV	VITON® O-Ring for 1-1/2" & 2" Clean Out Plug
6	LS212SS	12 Mesh for 1-1/2" & 2" Y Strainers; 316SS
6	LS220SS	20 Mesh for 1-1/2" & 2" Y Strainers; 316SS
6	LS230SS	30 Mesh for 1-1/2" & 2" Y Strainers; 316SS
6	LS250SS	50 Mesh for 1-1/2" & 2" Y Strainers; 316SS
6	LS280SS	80 Mesh for 1-1/2" & 2" Y Strainers; 316SS
5	LS150B	1-1/2" Female NPT; Y Strainer Body
5	LS200B	2" Female NPT; Y Strainer Body
N/S	LS150BC	1-1/2" Y Strainer Kit includes 1-5
N/S	LS200BC	2" Y Strainer Kit includes 1-5

# STRAINER SCREENS



Stamped P/N

## Line Strainer Screens

PART #	DESCRIPTION
LS720SS	20 Mesh for 1/2" & 3/4" Y-Strainers ; 316SS
LS740SS	40 Mesh for 1/2" & 3/4" Y-Strainers ; 316SS
LS780SS	80 Mesh for 1/2" & 3/4" Y-Strainers ; 316SS
LS120SS	20 Mesh for 1" & 1-1/4" Y-Strainers ; 316SS
LS140SS	40 Mesh for 1" & 1-1/4" Y-Strainers ; 316SS
LS180SS	80 Mesh for 1" & 1-1/4" Y-Strainers ; 316SS
LS212SS	12 Mesh for 1-1/2" & 2" Y-Strainers ; 316SS
LS220SS	20 Mesh for 1-1/2" & 2" Y-Strainers ; 316SS
LS230SS	30 Mesh for 1-1/2" & 2" Y-Strainers ; 316SS
LS250SS	50 Mesh for 1-1/2" & 2" Y-Strainers ; 316SS
LS280SS	80 Mesh for 1-1/2" & 2" Y-Strainers ; 316SS
LST130SS	30 Mesh for 3/4" & 1" T-Strainers ; 316SS
LST150SS	50 Mesh for 3/4" & 1" T-Strainers ; 316SS
LST180SS	80 Mesh for 3/4" & 1" T-Strainers ; 316SS
LST1100SS	100 Mesh for 3/4" & 1" T-Strainers ; 316SS
LST1530SS	30 Mesh for 1-1/2" & 2" T-Strainers ; 316SS
LST1550SS	50 Mesh for 1-1/2" & 2" T-Strainers ; 316SS
LST1580SS	80 Mesh for 1-1/2" & 2" T-Strainers ; 316SS
LST15100SS	100 Mesh for 1-1/2" & 2" T-Strainers ; 316SS



## Perforated Line Strainer Screens

Screen fits: LS150, LS200 & LS220

PART #	DESCRIPTION
PLS250SS	50 Mesh for 1-1/2" & 2" Y-Strainers ; 316SS
PLS280SS	80 Mesh for 1-1/2" & 2" Y-Strainers ; 316SS

## Black Poly Top & Clear Nylon Bowl In-Line Strainer

PART #	DESCRIPTION
LSTM05050C	1/2" Poly T-Strainer 50 Mesh
LSTM05080C	1/2" Poly T-Strainer 80 Mesh
LSTM07550C	3/4" Poly T-Strainer 50 Mesh
LSTM07580C	3/4" Poly T-Strainer 80 Mesh
LSTM10050C	1" Poly T-Strainer 50 Mesh
LSTM10080C	1" Poly T-Strainer 80 Mesh
LSTM12550C	1-1/4" Poly T-Strainer 50 Mesh
LSTM12580C	1-1/4" Poly T-Strainer 80 Mesh
LSTM15050C	1-1/2" Poly T-Strainer 50 Mesh
LSTM15080C	1-1/2" Poly T-Strainer 80 Mesh



- EPDM Gaskets
- Stainless Steel Screens

Replacement Gaskets  
& Screens Available

Viton Gaskets Available

## Replacement Screens for Black Poly Top & Clear Nylon Bowl In-Line Strainer

PART #	DESCRIPTION
LSTM05050S	Screen; 50 Mesh for 1/2" & 3/4" Mini T-Strainers; Blue
LSTM05080S	Screen; 80 Mesh for 1/2" & 3/4" Mini T-Strainers; White
LSTM10050S	Screen; 50 Mesh for 1" Mini T-Strainers; Blue
LSTM10080S	Screen; 80 Mesh for 1" Mini T-Strainers; White
LSTM12550S	Screen; 50 Mesh for 1-1/4" Mini T-Strainers; Blue
LSTM12580S	Screen; 80 Mesh for 1-1/4" Mini T-Strainers; White
LSTM15050S	Screen; 50 Mesh for 1-1/2" Mini T-Strainers; Blue
LSTM15080S	Screen; 80 Mesh for 1-1/2" Mini T-Strainers; White



## Polypropylene Basket Suction Strainer

*Polypropylene Strainer*



PART #	DESCRIPTION
SR150P	1-1/2" Female NPT
SR200P	2" Female NPT
SR300P	3" Female NPT

## Round Hole Steel Basket Strainer

Zinc Plated, with standard Pipe Threads



PART #	DESCRIPTION
SR125SP	1-1/4" Female NPT
SR150SP	1-1/2" Female NPT
SR200SP	2" Female NPT
SR300SP	3" Female NPT

# Bulkhead Fittings

## FEATURED ITEMS —

**Manifold Bulkhead Fitting**



**Polypropylene Bulkhead Fitting**



**Nylon Bulkhead Fitting**



### ***Selection***

These heavy duty fittings are available in sizes ranging from 1/2" to 4".

### ***Durability***

TerreMax's fittings are utilized for a variety of agricultural, plumbing and industrial liquid-handling solutions.

### ***Polypropylene***

Our resin is a high-strength, custom blended, glass-filled polypropylene.

### ***Knowledge***

Let us use our expertise to help you make the right choice.

### ***Experience***

We have been producing high quality fittings for over 4 decades.





MTF220



## Manifold Bulkhead Fitting

Glass Reinforced Polypropylene  
EDPM standard

PART #	QTY	THREAD	WASHER	HOLE SIZE
<b>INTERNAL SEALING</b>				
<b>POLY</b>				
MTF220	300 / Box	2" FP Flange x 2" Female NPT	EPDM	3-1/4"
MTF220V	30 / Box	2" FP Flange x 2" Female NPT	VITON	3-1/4"
MTF300	8 / Box	3" Flange x 3" Female NPT	EPDM	4-1/2"
MTF300V	8 / Box	3" Flange x 3" Female NPT	VITON	4-1/2"

Viton Gasket



Gasket Retention Groove

## Bulkhead Fitting

Material:

- Body and Nut are Polypropylene (P)
- Friction washer is Polyethylene
- Sealing washer is either EPDM (E) or Viton.

PART #	QTY	THREAD	WASHER	HOLE SIZE
<b>INTERNAL SEALING</b>				
<b>POLY</b>				
TF050	150 / Box	1/2" Female NPT	EPDM	1-5/8"
TF050V	150 / Box	1/2" Female NPT	VITON	1-5/8"
TF075	150 / Box	3/4" Female NPT	EPDM	1-5/8"
TF075V	150 / Box	3/4" Female NPT	VITON	1-5/8"
TF100	85 / Box	1" Female NPT	EPDM	2-1/4"
TF100V	85 / Box	1" Female NPT	VITON	2-1/4"
TF125	85 / Box	1 1/4" Female NPT	EPDM	2-1/4"
TF125V	85 / Box	1-1/4" Female NPT	VITON	2-1/4"
TF150	40 / Box	1 1/2" Female NPT	EPDM	3"
TF150V	40 / Box	1-1/2" Female NPT	VITON	3"
TF200	40 / Box	2" Female NPT	EPDM	3"
TF200V	40 / Box	2" Female NPT	VITON	3"
TF220	30 / Box	2" Female NPT	EPDM	3-1/4"
TF220V	30 / Box	2" Female NPT	VITON	3-1/4"
TF300	8 / Box	3" Female NPT	EPDM	4-1/2"
TF300V	8 / Box	3" Female NPT	VITON	4-1/2"
TF400	3 / Box	4" Female NPT	EPDM	5-3/4"

External Thread and nut are left hand threads.  
Internal Thread is FPT.  
For use with tanks having a wall thickness of 1/16" to 1/2".



EPDM



VITON

## Bulkhead Gaskets

PART #	DESCRIPTION
TF050075G	Gasket for 3/4" & 1/2"; EPDM
TF050075GV	Gasket for 3/4" & 1/2"; Viton
TF100125G	Gasket for 1" & 1-1/4"; EPDM
TF100125GV	Gasket for 1" & 1-1/4"; Viton
TF150200G	Gasket for 1-1/2 & 2"; EPDM
TF150200GV	Gasket for 1-1/2 & 2"; Viton
TF220G	Gasket for 2"; EPDM
TF220GV	Gasket for 2"; Viton
TF300G	Gasket for 3"; EPDM
TF300GV	Gasket for 3"; Viton
TF400G	Gasket for 4"; EPDM

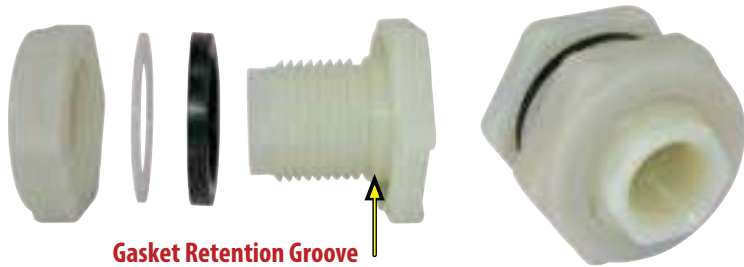

**Gasket Retention Groove**

Material:

- Body and Nut are Nylon (N)
- Friction washer is Polyethylene
- Sealing washer is either Buna (B), EPDM (E).

## Bulkhead Fitting

External Thread and nut are left hand threads.

Internal Thread is FPT.

For use with tanks having a wall thickness of 1/16" to 1/2".

PART #	THREAD	WASHER	HOLE SIZE
<b>INTERNAL SEALING</b>			
<b>NYLON</b>			
TF12NB	1/2" Female NPT	BUNA	1-5/8"
TF12NE	1/2" Female NPT	EPDM	1-5/8"
TF34NB	3/4" Female NPT	BUNA	1-5/8"
TF34NE	3/4" Female NPT	EPDM	1-5/8"

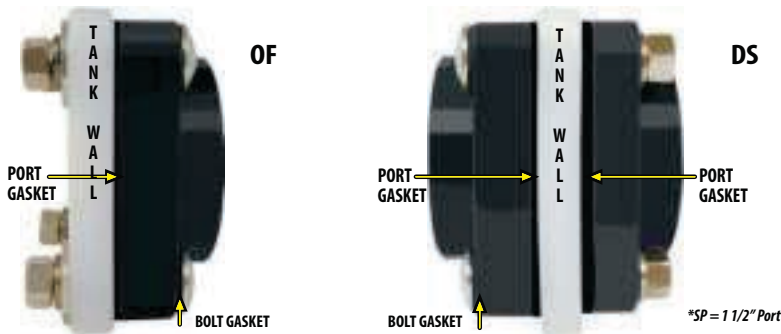

Fits Tank Wall thickness from 1/4" - 1/2"

- Polypropylene Flanges
- Stainless Steel bolts, nuts & washers
- EPDM Gaskets

## Outlet Flange

For use when access to inside of tank is available

PART #	DESCRIPTION
OF125	1-1/4" Female NPT Full Port
OF150	1-1/2" Female NPT Full Port
OF200FP	2" Female NPT Full Port

## Inside Bolt Seal Double Seal Flange

Nuts are tightened from outside of tank

PART #	INLET x OUTLET
DS125	1-1/4" SP* x 1-1/4" Full Port
DS150	1-1/2" SP* x 1-1/2" Full Port
DS200FP	2" Full Port x 2" Full Port



## Siphon Tube

Full Flow Size

Male NPT Threads

Polypropylene

PART #	DESCRIPTION
ST200SH	2" Poly Siphon Tube x 5" long
ST200	2" Poly Siphon Tube x 12" long
ST300	3" Poly Siphon Tube x 12" long



## Dry Poppet Couplings

PART #	DESCRIPTION	Size	Max. PSI
QD100F	Female Dry Poppet Coupler, 1" Female NPT Threads FKM (viton type) Seals	1"	70
QD100M	Male Dry Poppet Adapter, 1" Female NPT, 2" Buttress, Threads FKM (viton type) Seals	1"	70
QD100NPS	Male Dry Poppet Adapter, 1" Female NPT, 2" NPS, Threads FKM (viton type) Seals	1"	70

### Dry Poppet Coupling features:

- Lightweight
- Minimal Fluid Spillage
- Easy to Use
- Economical
- PTFE filled Polyethylene Seats
- Reduced Risk of Exposure
- Wide Range of Chemical Resistance
- Maximum Operating Pressure 70 P.S.I. @ 70°F
- Maximum Operating Temperature 150°F
- 30 GPM Maximum Flow
- Precision Molded in Polypropylene
- 1" Female NPT Threads

### Applications:

- Agriculture
- Industrial
- Pharmaceutical
- Chemical processing

# Schedule 80

## FEATURED ITEMS —

**90° Sweep  
Hose Barb**



**90°  
Hose Barb**



**Reducing  
Nipple**



**Nipple**



**Reducer  
Bushing**



## ***Selection***

Schedule 80 heavy duty fittings are available in sizes ranging from 1/2" to 3".

## ***Durability***

TerreMax's hose & pipe fittings are utilized for a variety of agricultural, plumbing and industrial liquid-handling solutions.

## ***Polypropylene***

Our resin is a high-strength, custom blended, glass-filled polypropylene.

## ***Custom***

Can't find what you're looking for in our fitting line? No worries, we make custom fittings as well!

## ***Knowledge***

Let us use our expertise to help you make the right choice.

## ***Experience***

We have been producing high quality fittings for over 4 decades.



## Straight Adapter

PART #	SIZE & DESCRIPTION
HB025	1/4" Male NPT x 1/4" Hose Barb
HB025038	1/4" Male NPT x 3/8" Hose Barb
HB025050	1/4" Male NPT x 1/2" Hose Barb
HB038	3/8" Male NPT x 3/8" Hose Barb
HB038025	3/8" Male NPT x 1/4" Hose Barb
HB038050	3/8" Male NPT x 1/2" Hose Barb
HB050038	1/2" Male NPT x 3/8" Hose Barb
HB050	1/2" Male NPT x 1/2" Hose Barb
HB050075	1/2" Male NPT x 3/4" Hose Barb
HB075038	3/4" Male NPT x 3/8" Hose Barb
HB075050	3/4" Male NPT x 1/2" Hose Barb
HB075	3/4" Male NPT x 3/4" Hose Barb
HB075100	3/4" Male NPT x 1" Hose Barb
HB100075	1" Male NPT x 3/4" Hose Barb
HB100	1" Male NPT x 1" Hose Barb
HB100125	1" Male NPT x 1-1/4" Hose Barb
HB125100	1-1/4" Male NPT x 1" Hose Barb
HB125	1-1/4" Male NPT x 1-1/4" Hose Barb
HB150100	1-1/2" Male NPT x 1" Hose Barb
HB150125	1-1/2" Male NPT x 1-1/4" Hose Barb
HB150	1-1/2" Male NPT x 1-1/2" Hose Barb
HB150200	1-1/2" Male NPT x 2" Hose Barb
HB200150	2" Male NPT x 1-1/2" Hose Barb
HB200	2" Male NPT x 2" Hose Barb
HB300	3" Male NPT x 3" Hose Barb



## 90° Sweep Hose Barb

PART #	DESCRIPTION
HB075SW90	3/4" Male NPT x 3/4" Hose Barb Elbow
HB100SW90	1" Male NPT x 1" Hose Barb Elbow
HB125SW90	1-1/4" Male NPT x 1-1/4" Hose Barb Elbow
HB150SW90	1-1/2" Male NPT x 1-1/2" Hose Barb Elbow
HB200SW90	2" Male NPT x 2" Hose Barb Elbow
HB300SW90	3" Male NPT x 3" Hose Barb Elbow



## Female Thread Hose Barb

PART #	DESCRIPTION
HBF200	2" Female NPT X 2" Hose Barb



## Straight Hose Mender

PART #	DESCRIPTION
HM075	3/4" Hose Barb x 3/4" Hose Barb
HM100	1" Hose Barb x 1" Hose Barb
HM125	1-1/4" Hose Barb x 1-1/4" Hose Barb
HM150	1-1/2" Hose Barb x 1-1/2" Hose Barb
HM200	2" Hose Barb x 2" Hose Barb
HM300	3" Hose Barb x 3" Hose Barb



## 90° Hose Barb

PART #	DESCRIPTION
HB02590	1/4" Male NPT x 1/4" Hose Barb 90° Elbow
<b>NEW</b> HB02503890	1/4" Male NPT x 3/8" Hose Barb 90° Elbow
<b>NEW</b> HB02505090	1/4" Male NPT x 1/2" Hose Barb 90° Elbow
HB03890	3/8" Male NPT x 3/8" Hose Barb 90° Elbow
<b>NEW</b> HB05003890	1/2" Male NPT x 3/8" Hose Barb 90° Elbow
HB05090	1/2" Male NPT x 1/2" Hose Barb 90° Elbow
HB05007590	1/2" Male NPT x 3/4" Hose Barb 90° Elbow
HB07505090	3/4" Male NPT x 1/2" Hose Barb 90° Elbow
HB07590	3/4" Male NPT x 3/4" Hose Barb 90° Elbow
HB07510090	3/4" Male NPT x 1" Hose Barb 90° Elbow
<b>NEW</b> HB10007590	1" Male NPT x 3/4" Hose Barb 90° Elbow
HB10090	1" Male NPT x 1" Hose Barb 90° Elbow
<b>NEW</b> HB10012590	1" Male NPT x 1-1/4" Hose Barb 90° Elbow
HB12510090	1-1/4" Male NPT x 1" Hose Barb 90° Elbow
HB12590	1-1/4" Male NPT x 1-1/4" Hose Barb 90° Elbow
<b>NEW</b> HB12515090	1-1/4" Male NPT x 1-1/2" Hose Barb 90° Elbow
<b>NEW</b> HB15012590	1-1/2" Male NPT x 1-1/4" Hose Barb 90° Elbow
HB15090	1-1/2" Male NPT x 1-1/2" Hose Barb 90° Elbow
<b>NEW</b> HB20015090	2" Male NPT x 1-1/2" Hose Barb 90° Elbow
HB20090	2" Male NPT x 2" Hose Barb 90° Elbow
HB30090	3" Male NPT x 3" Hose Barb 90° Elbow

# SCHEDULE 80 HEAVY DUTY



## Elbow

PART #	DESCRIPTION
ELF12P	1/2" Female NPT x 1/2" Female NPT
ELF34P	3/4" Female NPT x 3/4" Female NPT
ELF100P	1" Female NPT x 1" Female NPT
ELF114P	1-1/4" Female NPT x 1-1/4" Female NPT
ELF112P	1-1/2" Female NPT x 1-1/2" Female NPT
ELF200P	2" Female NPT x 2" Female NPT
ELF300P	3" Female NPT x 3" Female NPT



## Reducing Coupling

PART #	DESCRIPTION
RC100075	1" Female NPT x 3/4" Female NPT
RC150100	1-1/2" Female NPT x 1" Female NPT
RC200100	2" Female NPT x 1" Female NPT
RC200150	2" Female NPT x 1-1/2" Female NPT
RC300200	3" Female NPT x 2" Female NPT



## Street Elbow

PART #	DESCRIPTION
SE14P	1/4" Female NPT x 1/4" Male NPT 90° Street Elbow
SE38P	3/8" Female NPT x 3/8" Male NPT 90° Street Elbow
SE12P	1/2" Female NPT x 1/2" Male NPT 90° Street Elbow
SE1234P	3/4" Female NPT x 1/2" Male NPT 90° Street Elbow
SE34P	3/4" Female NPT x 3/4" Male NPT 90° Street Elbow
SE100P	1" Female NPT x 1" Male NPT 90° Street Elbow
SE114P	1-1/4" Female NPT x 1-1/4" Male NPT 90° Street Elbow
SE112P	1-1/2" Female NPT x 1-1/2" Male NPT 90° Street Elbow
SE200P	2" Female NPT x 2" Male NPT 90° Street Elbow
SE300P	3" Female NPT x 3" Male NPT 90° Street Elbow



## Reducing Nipple

PART #	DESCRIPTION
RN075050	3/4" Male NPT x 1/2" Male NPT
RN100075	1" Male NPT x 3/4" Male NPT
RN150100	1-1/2" Male NPT x 1" Male NPT
RN200150	2" Male NPT x 1-1/2" Male NPT
RN300200	3" Male NPT x 2" Male NPT



## Nipple

PART #	DESCRIPTION
M1800P	1/8" Male NPT Short Poly Nipple
M1400P	1/4" Male NPT Short Poly Nipple
<b>NEW</b>	NIP038-SH
<b>NEW</b>	NIP050-SH
<b>NEW</b>	NIP075-SH
	M0754P
<b>NEW</b>	NIP100-SH
	M1004P
	M1006P
<b>NEW</b>	NIP125-SH
	M1254P
	M1256P
<b>NEW</b>	NIP150-SH
	M1124P
	M1126P
<b>NEW</b>	NIP200-SH
	M2004P
	M2006P
<b>NEW</b>	NIP300-SH
	M3006P



## Reducer Bushing

PART #	SIZE & DESCRIPTION
RB050038	1/2" Male NPT x 3/8" Female NPT
RB075050	3/4" Male NPT x 1/2" Female NPT
RB100075	1" Male NPT x 3/4" Female NPT
RB125100	1-1/4" Male NPT x 1" Female NPT
RB150125	1-1/2" Male NPT x 1-1/4" Female NPT
RB200075	2" Male NPT x 3/4" Female NPT
RB200150	2" Male NPT x 1-1/2" Female NPT
RB300200HD	3" Male NPT x 2" Female NPT



## Coupling

PART #	DESCRIPTION
CPLG038	3/8" Female NPT x 3/8" Female NPT
CPLG050	1/2" Female NPT x 1/2" Female NPT
CPLG075	3/4" Female NPT x 3/4" Female NPT
CPLG100	1" Female NPT x 1" Female NPT
CPLG125	1-1/4" Female NPT x 1-1/4" Female NPT
CPLG150	1-1/2" Female NPT x 1-1/2" Female NPT
CPLG200	2" Female NPT x 2" Female NPT
CPLG300	3" Female NPT x 3" Female NPT



## Tee

PART #	DESCRIPTION
TT14P	1/4" Female NPT
TT12P	1/2" Female NPT
TT34P	3/4" Female NPT
TT100P	1" Female NPT
TT114P	1-1/4" Female NPT
TT112P	1-1/2" Female NPT
TT200P	2" Female NPT
TT300P	3" Female NPT



## Tee w Gauge Port

PART #	DESCRIPTION
TT1214P	1/2" Female NPT x 1/4" Gauge Port
TT3414P	3/4" Female NPT x 1/4" Gauge Port
TT10014P	1" Female NPT x 1/4" Gauge Port



## 45° Street Elbow

PART #	DESCRIPTION
SL15045	1-1/2" Female NPT x 1-1/2" Male NPT
SL20045	2" Female NPT x 2" Male NPT



## Pipe Caps

PART #	DESCRIPTION
CAP050	1/2" Female NPT Poly Cap
CAP075	3/4" Female NPT Poly Cap
CAP100	1" Female NPT Poly Cap
CAP125	1-1/4" Female NPT Poly Cap
CAP150	1-1/2" Female NPT Poly Cap
CAP200	2" Female NPT Poly Cap
CAP300	3" Female NPT Poly Cap



## Plug

PART #	DESCRIPTION
PLUG050	1/2" Plug
PLUG075	3/4" Plug
PLUG100	1" Plug
PLUG150	1-1/2" Plug
PLUG200	2" Plug
PLUG300	3" Plug



## Steel Plated Straight Adapters

PART #	DESCRIPTION
CN050SP	1/2" Male NPT x 1/2" Hose Barb
CN075SP	3/4" Male NPT x 3/4" Hose Barb
CN100SP	1" Male NPT x 1" Hose Barb
CN125SP	1-1/4" Male NPT x 1-1/4" Hose Barb
CN150SP	1-1/2" Male NPT x 1-1/2" Hose Barb
CN200SP	2" Male NPT x 2" Hose Barb

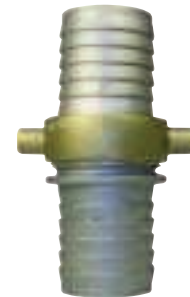

## Pin Lug Couplers

- Pin Lug Hose Barb Couplers (Full Sets)
- Aluminum Shank with Brass Swivel Nut

PART #	DESCRIPTION
PL150DP	1-1/2" Hose Barbs
PL200DP	2" Hose Barbs
PG150NBR	1-1/2" Gasket
PG200NBR	2" Gasket

# Fittings

## FEATURED ITEMS —

### Hose Fitting



### Pipe Fitting



### Garden Hose Fitting



### Nozzle Fitting



### **Selection**

Hose, pipe, garden hose, nozzle, and heavy duty fittings are available in sizes ranging from 1/8" to 3".

### **Durability**

TerreMax's hose & pipe fittings are utilized for a variety of agricultural, plumbing, and industrial liquid-handling solutions.

### **Polypropylene**

Our resin is a high strength custom blended glass filled polypropylene.

### **Nylon**

TerreMax's hose & pipe fittings are certified by NSF International NSF/ANSI Standard 61 – Drinking Water System Components, Health Effects and NSF/ANSI Standard 372 – Drinking Water System Components, Lead Content.

### **Experience**

We have been manufacturing top quality fittings since 1983.

For additional information, visit our website:  
[www.TerreMax.us](http://www.TerreMax.us)





## Straight Adapter

Use in conjunction with a hose clamp and quality thread sealant.



PART #		THREAD	HOSE BARB
NYLO	POLY	Male NPT x	HOSE BARB
A18316		1/8"	3/16"
A1814	A1814P	1/8"	1/4"
A18516		1/8"	5/16"
A1838	A1838P	1/8"	3/8"
A1812	A1812P	1/8"	1/2"
A1414	A1414P	1/4"	1/4"
A14516		1/4"	5/16"
A1438	A1438P	1/4"	3/8"
A1412	A1412P	1/4"	1/2"
A1458	A1458P	1/4"	5/8"
A1434	A1434P	1/4"	3/4"
A3814	A3814P	3/8"	1/4"
A38516		3/8"	5/16"
A3838	A3838P	3/8"	3/8"
A3812	A3812P	3/8"	1/2"
A3858	A3858P	3/8"	5/8"
A3834	A3834P	3/8"	3/4"
A1214	A1214P	1/2"	1/4"
A1238	A1238P	1/2"	3/8"
A1212	A1212P	1/2"	1/2"
A1258	A1258P	1/2"	5/8"
A1234	A1234P	1/2"	3/4"
A1210	A1210P	1/2"	1"
A12114	A12114P	1/2"	1-1/4"
A3414	A3414P	3/4"	1/4"
A3438	A3438P	3/4"	3/8"
A3412	A3412P	3/4"	1/2"
A3458	A3458P	3/4"	5/8"
A3434	A3434P	3/4"	3/4"
A3410	A3410P	3/4"	1"
A34114	A34114P	3/4"	1-1/4"
A1038	A1038P	1"	3/8"
A1012	A1012P	1"	1/2"
A1058	A1058P	1"	5/8"
A1034	A1034P	1"	3/4"
A1010	A1010P	1"	1"
A1114	A1114P	1"	1-1/4"
A11434	A11434P	1-1/4"	3/4"
A1141	A1141P	1-1/4"	1"
A114	A114P	1-1/4"	1-1/4"
A114112	A114112P	1-1/4"	1-1/2"
A1121	A1121P	1-1/2"	1"
A112	A112P	1-1/2"	1-1/2"
A112114	A112114P	1-1/2"	1-1/4"
A112200	A112200P	1-1/2"	2"
A200112	A200112P	2"	1-1/2"
A200	A200P	2"	2"



## 90 Degree Elbow

Use in conjunction with a hose clamp and quality thread sealant.

PART #		THREAD	HOSE BARB
NYLO	POLY	Male NPT x HOSE BARB	
EL18316		1/8"	3/16"
EL1814	EL1814P	1/8"	1/4"
EL1838		1/8"	3/8"
EL1414	EL1414P	1/4"	1/4"
EL14516		1/4"	5/16"
EL1438	EL1438P	1/4"	3/8"
EL1412	EL1412P	1/4"	1/2"
EL1458	EL1458P	1/4"	5/8"
EL3814	EL3814P	3/8"	1/4"
EL38516		3/8"	5/16"
EL3838	EL3838P	3/8"	3/8"
EL3812	EL3812P	3/8"	1/2"
EL3858	EL3858P	3/8"	5/8"
EL1214	EL1214P	1/2"	1/4"
EL1238	EL1238P	1/2"	3/8"
EL1212	EL1212P	1/2"	1/2"
EL1258	EL1258P	1/2"	5/8"
EL1234	EL1234P	1/2"	3/4"
EL3414	EL3414P	3/4"	1/4"
EL3438	EL3438P	3/4"	3/8"
EL3412	EL3412P	3/4"	1/2"
EL3458	EL3458P	3/4"	5/8"
EL3434	EL3434P	3/4"	3/4"
EL3410	EL3410P	3/4"	1"
EL1038	EL1038P	1"	3/8"
EL1012	EL1012P	1"	1/2"
EL1058	EL1058P	1"	5/8"
EL1034	EL1034P	1"	3/4"
EL1010	EL1010P	1"	1"
EL1114	EL1114P	1"	1-1/4"
EL11434	EL11434P	1-1/4"	3/4"
EL1141	EL1141P	1-1/4"	1"
EL114	EL114P	1-1/4"	1-1/4"
EL112	EL112P	1-1/2"	1-1/2"
EL200	EL200P	2"	2"



## 90 Degree Elbow

Use in conjunction with a hose clamp and quality thread sealant.

PART #		THREAD	HOSE BARB
NYLON	POLY	Female NPT x HOSE BARB	
EL1212F	EL1212FP	1/2"	1/2"
EL3412F	EL3412FP	3/4"	1/2"
EL3434F	EL3434FP	3/4"	3/4"





## Straight Hose Mender

Used in fluid plumbing applications requiring the connection of two hoses. Commonly called a hose splice fitting or a shim fitting.

PART #		BARB 1	BARB 2
NYLON	POLY	HOSE BARB x HOSE BARB	
SHM1800	SHM1800P	1/8"	1/8"
SHM3160	SHM3160P	3/16"	3/16"
SHM1418		1/4"	1/8"
SHM14316		1/4"	3/16"
SHM1400	SHM1400P	1/4"	1/4"
SHM5160	SHM5160P	5/16"	5/16"
SHM3800	SHM3800P	3/8"	3/8"
SHM3814	SHM3814P	3/8"	1/4"
SHM1214	SHM1214P	1/2"	1/4"
SHM1200	SHM1200P	1/2"	1/2"
SHM1238	SHM1238P	1/2"	3/8"
SHM1258	SHM1258P	1/2"	5/8"
SHM5800	SHM5800P	5/8"	5/8"
SHM3412		3/4"	1/2"
SHM3400	SHM3400P	3/4"	3/4"
SHM1000	SHM1000P	1"	1"
SHM114	SHM114P	1-1/4"	1-1/4"
SHM112	SHM112P	1-1/2"	1-1/2"
SHM200	SHM200P	2"	2"



## Tee Adapter

Used in fluid plumbing applications requiring a connection of two hoses to a Female NPT fitting and a hose.

PART #		THREAD	HOSE BARB
NYLON	POLY	Male NPT x HOSE BARB	
MT1234	MT1234P	1/2"	3/4"
MT3438	MT3438P	3/4"	3/8"
MT3412	MT3412P	3/4"	1/2"
MT3434	MT3434P	3/4"	3/4"
MT1012	MT1012P	1"	1/2"
MT1034	MT1034P	1"	3/4"



## Elbow Barb

Use in conjunction with a hose clamp.

PART #		BARB 1	BARB 2
NYLON	POLY	HOSE BARB x 90 DEGREE HOSE BARB	
EB1414	EB1414P	1/4"	1/4"
EB3838	EB3838P	3/8"	3/8"
EB1212	EB1212P	1/2"	1/2"
EB5858	EB5858P	5/8"	5/8"
EB3434	EB3434P	3/4"	3/4"
EB1034	EB1034P	1"	3/4"
EB1010	EB1010P	1"	1"
EB114	EB114P	1-1/4"	1-1/4"
EB112	EB112P	1-1/2"	1-1/2"
EB200	EB200P	2"	2"



## Insert Tee

Use in conjunction with a hose clamp.

PART #		BARB 1	BARB 2	BARB 3
<b>NYLON</b>	<b>POLY</b>			
T18	T18P	1/8"	1/8"	1/8"
T3160		3/16"	3/16"	3/16"
T14	T14P	1/4"	1/4"	1/4"
T38	T38P	3/8"	3/8"	3/8"
T3812	T3812P	1/2"	1/2"	3/8"
T12	T12P	1/2"	1/2"	1/2"
T58	T58P	5/8"	5/8"	5/8"
T3412	T3412P	1/2"	1/2"	3/4"
T34	T34P	3/4"	3/4"	3/4"
T100	T100P	1"	1"	1"
T114	T114P	1-1/4"	1-1/4"	1-1/4"
T112	T112P	1-1/2"	1-1/2"	1-1/2"
T200	T200P	2"	2"	2"



## Straight Adapter

Used in fluid plumbing applications requiring straight connection to a Male fitting and a hose.

PART #		THREAD	HOSE BARB
<b>NYLON</b>	<b>POLY</b>	<b>Female NPT x</b>	<b>HOSE BARB</b>
AF1414		1/4"	1/4"
AF1438		1/4"	3/8"
AF3838	AF3838P	3/8"	3/8"
Af3812	AF3812P	3/8"	1/2"
AF1212	AF1212P	1/2"	1/2"
AF1238	AF1238P	1/2"	3/8"
	AF1234P	1/2"	3/4"
AF3412	AF3412P	3/4"	1/2"
AF3458	AF3458P	3/4"	5/8"
AF3434	AF3434P	3/4"	3/4"



## Cross Barb

Used in fluid applications requiring the connection of four hoses. Commonly called a junction fitting.

PART #		HOSE BARB
<b>NYLON</b>	<b>POLY</b>	
X14	X14P	1/4"



## Flat Seat Hose Barb

Used with swivel nut B3400 and washer W406 shown in this catalog. Combining the three pieces allows for a swivel connection of common size hoses.

PART #		HOSE BARB
<b>NYLON</b>	<b>POLY</b>	<b>BARB x FLAT SEAT</b>
C1800	C1800P	1/8"
C1400	C1400P	1/4"
C3800	C3800P	3/8"
C1200	C1200P	1/2"
C5800	C5800P	5/8"
C3400	C3400P	3/4"





**Reducer Bushing**

Used in fluid plumbing applications to connect a Female NPT thread to a reduced size of a Male NPT fitting.

PART #		THREAD	
NYLON	POLY	Male NPT x	Female NPT
RB1418	RB1418P	1/4"	1/8"
RB3818	RB3818P	3/8"	1/8"
RB3814	RB3814P	3/8"	1/4"
RB1218	RB1218P	1/2"	1/8"
RB1214	RB1214P	1/2"	1/4"
RB1238	RB1238P	1/2"	3/8"
RB3418	RB3418P	3/4"	1/8"
RB3414	RB3414P	3/4"	1/4"
RB3438	RB3438P	3/4"	3/8"
RB3412	RB3412P	3/4"	1/2"
RB1012	RB1012P	1"	1/2"
RB1034	RB1034P	1"	3/4"
RB11434	RB11434P	1-1/4"	3/4"
RB1141	RB1141P	1-1/4"	1"
RB11234	RB11234P	1-1/2"	3/4"
RB1121	RB1121P	1-1/2"	1"
RB112114	RB112114P	1-1/2"	1-1/4"
RB2001	RB2001P	2"	1"
RB200114	RB200114P	2"	1-1/4"
RB200112	RB200112P	2"	1-1/2"
RB300200	RB300200P	3"	2"



**Elbow**

Used in fluid plumbing applications to connect to Male NPT fittings at 90 degrees.

PART #		THREAD
NYLON	POLY	Female NPT x 90 DEGREE Female NPT
ELF12	ELF12P	1/2"
ELF34	ELF34P	3/4"
ELF100	ELF100P	1"
ELF114	ELF114P	1-1/4"
ELF112	ELF112P	1-1/2"
ELF200	ELF200P	2"



**Coupling**

Used in fluid plumbing applications to connect two Male NPT fittings.

PART #		THREAD
NYLON	POLY	Female NPT
FTC14	FTC14P	1/4"
FTC38	CPLG038	3/8"
FTC12	CPLG050	1/2"
FTC34	CPLG075	3/4"
FTC100	CPLG100	1"
FTC114	CPLG125	1-1/4"
FTC112	CPLG150	1-1/2"
FTC200	CPLG200	2"

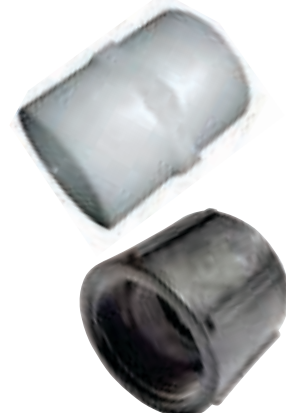

## Plug

Use in conjunction with a quality thread sealant.

PART #		THREAD
NYLON	POLY	Male NPT x HEX
F1800	F1800P	1/8"
F1400	F1400P	1/4"
F3800	F3800P	3/8"
F1200	F1200P	1/2"
F3400	F3400P	3/4"
F1000	F1000P	1"
F1014	F1014P	1-1/4"
F112	F112P	1-1/2"
F200		2"



## Nipple

Used in fluid plumbing application to connect two Female NPT fittings.

PART #		THREAD
NYLON	POLY	Male NPT x Male NPT
M1800	M1800P	1/8"
M1400	M1400P	1/4"
M3800	M3800P	3/8"
M1200	M1200P	1/2"
M3400	M3400P	3/4"
M1000	M1000P	1"
M1140	M1140P	1-1/4"
M1120	M1120P	1-1/2"
M2000	M2000P	2"



## Reducing Nipple

Used in fluid plumbing application to connect two Female NPT fittings.

PART #		THREAD	
NYLON	POLY	Male NPT x Male NPT	
RM1438	RM1438P	1/4"	3/8"
RM3818		3/8"	1/8"
RM3812	RM3812P	3/8"	1/2"
RM38116	RM38116P	3/8"	11/16" UN
RM12116	RM12116P	1/2"	11/16" UN
RM1214	RM1214P	1/2"	1/4"
RM3438	RM3438P	3/4"	3/8"
RM3412	RM3412P	3/4"	1/2"
RM34116	RM34116P	3/4"	11/16" UN
RM1141	RM1141P	1-1/4"	1"





## Tee

Used in fluid plumbing applications requiring the connection of three fittings or pipes all having Male NPT threads.

PART #		THREAD
NYLON	POLY	Female NPT
TT14	TT14P	1/4"
TT12	TT12P	1/2"
TT34	TT34P	3/4"
TT100	TT100P	1"
TT114	TT114P	1-1/4"
TT112	TT112P	1-1/2"
TT200	TT200P	2"
	TT300P	3"



## Tee with Gauge Port

Used in fluid plumbing applications requiring the connection of three fittings or pipes all having Male NPT threads. Special port extends from center of body for a gauge.

PART #		THREAD	PORT
NYLON	POLY	Female NPT	
TT1214	TT1214P	1/2"	1/4"
TT3418	TT3418P	3/4"	1/8"
TT3414	TT3414P	3/4"	1/4"
TT10014	TT10014P	1"	1/4"
TT11414		1-1/4"	1/4"
TT11214		1-1/2"	1/4"

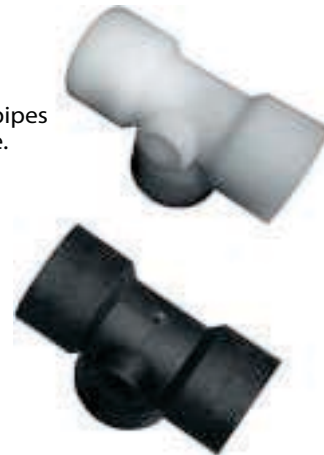

## Street Elbow

Used in fluid plumbing applications to connect a Female NPT fitting and a Male NPT at 90 degrees. This fitting is very useful when working space is a minimal.

PART #		THREAD	THREAD
NYLON	POLY	Male NPT x 90 Degree	Female NPT
SE14	SE14P	1/4"	1/4"
SE38	SE38P	3/8"	3/8"
SE12	SE12P	1/2"	1/2"
SE1234	SE1234P	1/2"	3/4"
SE34	SE34P	3/4"	3/4"
SE100	SE100P	1"	1"
SE114	SE114P	1-1/4"	1-1/4"
SE112	SE112P	1-1/2"	1-1/2"
SE200	SE200P	2"	2"





## Adapter

Garden Hose fitting used to connect a Female GHT fitting to a Male NPT fitting.

PART #		THREAD	THREAD
NYLON	POLY	3/4" Male GHT x Female NPT	
G3412	G3412P	3/4"	1/2"
G3434	G3434P	3/4"	3/4"



## Adapter

Garden Hose fitting used to connect a Female NPT fitting to a Male GHT fitting.

PART #		THREAD	THREAD
NYLON	POLY	Male NPT x 3/4" Female GHT	
H3434	H3434P	3/4"	3/4"



## Adapter

Garden Hose fitting used to connect two female fittings.

PART #		THREAD	THREAD
NYLON	POLY	Male GHT x Male NPT	
E3412	E3412P	3/4"	1/2"
E3438	E3438P	3/4"	3/8"
E3434	E3434P	3/4"	3/4"
EE3434	EE3434P	3/4"	3/4" Male GHT



## Adapter

Garden Hose fitting used to connect a Female GHT to a Male GHT fitting.  
Female GHT requires a W 406 washer.

PART #		THREAD	THREAD
NYLON	POLY	3/4" Male GHT x 3/4" Female GHT	
I3434	I3434P	3/4"	3/4"



## Coupling

Garden Hose fitting used to connect a Male GHT to a Male NPT fitting.  
Female GHT requires a W 406 washer.

PART #		THREAD	THREAD
NYLON	POLY	3/4" Female GHT x Female NPT	
J3412	J3412P	3/4"	1/2"







## Cap

Female thread x Closed end. Requires W 406 washer.

PART #		THREAD
NYLON	POLY	Female GHT & Female NPS
N3400	N3400P	3/4" Female GHT
N3400F	N3400FP	3/4" Female NPS



## Plug

Garden Hose fitting used to plug off a Female GHT fitting.

PART #			THREAD
NYLON	POLY	PRICE ea.	3/4" Male GHT x HEX
F3400GHT	F3400GHTP		3/4"



## Tee Adapter

Garden Hose fitting used to connect 3/4" Female GHT fitting to two hoses.

PART #			THREAD	HOSE BARB
NYLON	POLY	PRICE ea.	Male GHT x HOSE BARB	
MT3438G	MT3438GP		3/4"	3/8"
MT3412G	MT3412GP		3/4"	1/2"
MT3434G	MT3434GP		3/4"	3/4"



## Adapter

Garden Hose fitting used to connect 3/4" Female GHT fitting to a hose.

PART #		THREAD	HOSE BARB
NYLON	POLY	3/4" Male GHT x Hose Barb	
D3414	D3414P	3/4"	1/4"
D3438	D3438P	3/4"	3/8"
D3412	D3412P	3/4"	1/2"
D3458	D3458P	3/4"	5/8"
D3434	D3434P	3/4"	3/4"
D3410	D3410P	3/4"	1"



## Elbow

Garden Hose fitting used to connect 3/4" Female GHT to a hose at 90 degrees.

PART #		THREAD	HOSE BARB
NYLON	POLY	3/4" Male GHT x 90 degree	
EL3438G	EL3438GP	3/4"	3/8"
EL3412G	EL3412GP	3/4"	1/2"
EL3458G	EL3458GP	3/4"	5/8"
EL3434G	EL3434GP	3/4"	3/4"
EL3410G	EL3410GP	3/4"	1"





## Reducing Nipple

Garden Hose fitting used to connect two Female PT fittings.

PART #		THREAD	
NYLON	POLY	MALE GHT X MALE	
RM34116G	RM34116GP	3/4"	11/16" UN



## Swivel Nut

Garden Hose fitting used to connect a hose using a C series fitting with a washer.

PART #		THREAD
NYLON	POLY	3/4" Female GHT
B3400	B3400P	3/4" Female GHT
B3400F	B3400FP	3/4" Female NPS



## Washers

Vinyl Garden Hose washer. Used with all 3/4" Female GHT fittings in this catalog.

PART #	DESCRIPTION
W406	Vinyl Garden Hose Washer
W40650S	Vinyl Garden Hose Washer with 50 mesh screen

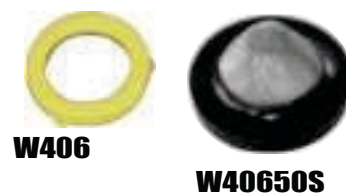

## 3-Piece Barb Assembly

Garden Hose fitting with swivel connection. Used to connect 3/4" Female GHT to a hose. Washer is vinyl in both nylon and poly assemblies.

PART #		SWIVEL	HOSE BARB	WASHER
NYLON	POLY			
B3414W	B3414WP	B3400	1/4"	W 406
B3438W	B3438WP	B3400	3/8"	W 406
B3412W	B3412WP	B3400	1/2"	W 406
B3458W	B3458WP	B3400	5/8"	W 406
B3434W	B3434WP	B3400	3/4"	W 406



## Garden Hose Shutoff Valves

Single and double garden hose valves with 3/4" GHT. 100 PSI maximum operating pressure. ABS construction.

PART #	DESCRIPTION
G3434V	3/4" Female GHT (inlet) x 3/4" Male GHT (1 outlet)
G3434YV	3/4" Female GHT (inlet) x 3/4" Male GHT (2 outlets)





## Hex Nut

Used to lock nozzle fitting in this catalog to Boom Clamp fittings.

PART #		THREAD
NYLON	POLY	
N1116	N1116P	11/16" Female UN



## Straight Adapter

Thread 11/16" male UN x hose barb, nut included. Used on the terminating ends of spray boom or a boom using a manifold.

PART #		HOSE BARB SIZE
NYLON	POLY	
3838D	3838DP	3/8"
3812D	3812DP	1/2"
3834D	3834DP	3/4"



## Elbow

Thread 11/16" male UN x hose barb, nut included. Used on the terminating ends of spray boom.

PART #		HOSE BARB SIZE
NYLON	POLY	
NTL38	NTL38P	3/8"
NTL12	NTL12P	1/2"
NTL34	NTL34P	3/4"



## Cross

Thread 11/16" male UN x hose barb, nut included. Used in the center of boom sections as a main feed line.

PART #		HOSE BARB SIZE
NYLON	POLY	
T38C	T38CP	3/8"
T12C	T12CP	1/2"
T34C	T34CP	3/4"



## Tee

Thread 11/16" male UN x hose barb, nut included. Used between the main feed lines and termination end of boom sections.

PART #		HOSE BARB SIZE
NYLON	POLY	
NTT38	NTT38P	3/8"
NTT12	NTT12P	1/2"
NTT34	NTT34P	3/4"





## Spray Tip Blank

Blanks for Boom Drops, used when changing row spacing.

PART #		THREAD
NYLON	POLY	
8028	8028P	11/16" Female UN



## Male Adapter

Allows 1/4" female boom drops to be converted to accept 11/16" UN swivel cap.

PART #		THREAD
NYLON	POLY	
NB164	NB164P	11/16" Male UN x 1/4" Male NPT
NB168		11/16" Male UN x 1/8" Male NPT



## Boom Clamp

Boom Clamps fit all nozzle thread fittings in this catalog.

PART #		SIZE
NYLON	POLY	
B111	B111P	Fits 1" Round or Square Tubing
B11114	B11114P	Fits 1 1/4" Round or Square Tubing



## Female Adapter

Allows 11/16" UN nozzle fittings in this catalog to be converted to accept 1/4" Male NPT flood tips.

PART #		THREAD
NYLON	POLY	
1116A	1116AP	11/16" Female UN x 1/4" Female NPT



## Swivel Nut

For use with Male Adapter and all nozzle fittings in this catalog. Fastens spray tips to nozzle fittings.

PART #		THREAD
NYLON	POLY	
8027	8027P	11/16" Female UN
8027W	8027WP	



## Metering Barb

Used to run a line from spray boom to a gauge for monitoring boom pressure. Connects to Male Adapter and all nozzle fittings in this catalog with a 8027 swivel nut.

PART #		BARB SIZE
NYLON	POLY	
K8414	K8414P	1/4"
K8438	K8438P	3/8"
K8412	K8412P	1/2"





## Pressure Gauges

### Standard Gauge

PART #	DESCRIPTION
SG060	2" Gauge, 60 PSI
SG100	2" Gauge, 100 PSI
SG200	2" Gauge, 200 PSI
SG400	2" Gauge, 400 PSI
SG1004	4" Gauge, 100 PSI

### Liquid Gauge

PART #	DESCRIPTION
LG100	2-1/2" Liquid Filled, 100 PSI
LG200	2-1/2" Liquid Filled, 200 PSI

### Ammonia Gauge

PART #	DESCRIPTION
AG060	Ammonia, 60 PSI

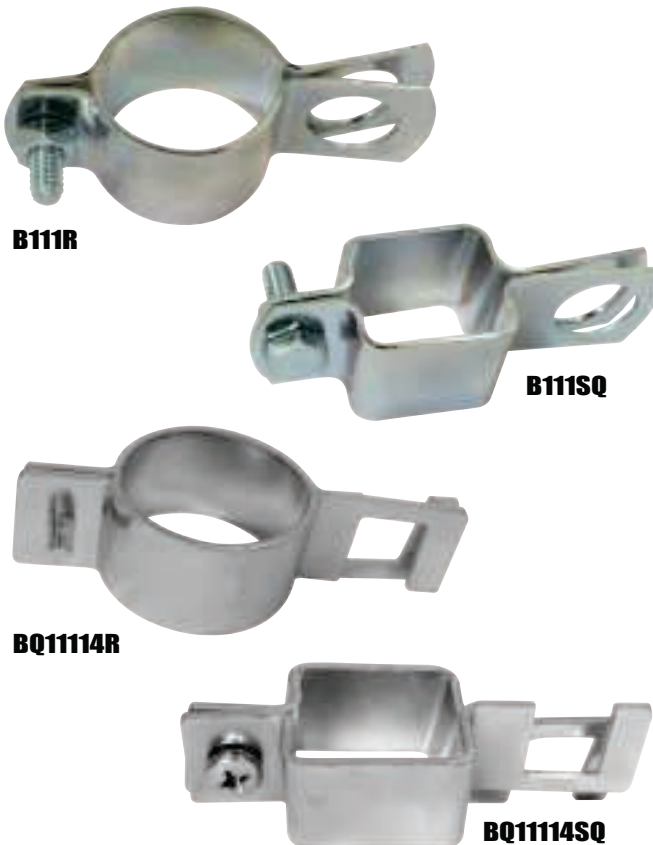

## Steel Boom Clamps

### Standard Clamps-Round

PART #	DESCRIPTION
B1134R	3/4"
B111R	1"

### Standard Clamps-Square

PART #	DESCRIPTION
B111SQ	1"
B11114SQ	1-1/4"

### Quick Clamps-Round

PART #	DESCRIPTION
BQ1134R	3/4"
BQ111R	1"
BQ11114R	1-1/4"

### Quick Clamps-Square

PART #	DESCRIPTION
BQ1134SQ	3/4"
BQ111SQ	1"
BQ11114SQ	1-1/4"
BQ11112SQ	1-1/2"

# BOOM COMPONENTS

DESCRIPTION	PART #	
Quick fit adapter, 1/4", nylon, QD adapter	Y8230021	1/4"



DESCRIPTION	PART #	
Dry boom nozzle body, 3/8", elbow barb	Y8231001	3/8"
Dry boom nozzle body, 1/2", elbow barb	Y8231003	1/2"
Dry boom nozzle body, 3/4", elbow barb	Y8231005	3/4"



DESCRIPTION	PART #	
Dry boom nozzle body, 3/8", tee barb	Y8231007	3/8"
Dry boom nozzle body, 1/2", tee barb	Y8231009	1/2"
Dry boom nozzle body, 3/4", tee barb	Y8231011	3/4"



DESCRIPTION	PART #	
Dry boom nozzle body, 3/8", cross barb	Y8231013	3/8"
Dry boom nozzle body, 1/2", cross barb	Y8231015	1/2"
Dry boom nozzle body, 3/4", cross barb	Y8231017	3/4"



DESCRIPTION	PART #	
Dry boom nozzle body, 3/8", elbow, top diaphragm	Y8235019	3/8"
Dry boom nozzle body, 1/2", elbow, top diaphragm	Y8235021	1/2"
Dry boom nozzle body, 3/4", elbow, top diaphragm	Y8235023	3/4"



DESCRIPTION	PART #	
Dry boom nozzle body, 3/8", tee, top diaphragm	Y8235025	3/8"
Dry boom nozzle body, 1/2", tee, top diaphragm	Y8235027	1/2"
Dry boom nozzle body, 3/4", tee, top diaphragm	Y8235029	3/4"



DESCRIPTION	PART #	
Dry boom nozzle body, 3/8", cross barb, side diaphragm	Y8235013	3/8"
Dry boom nozzle body, 1/2", cross barb, side diaphragm	Y8235015	1/2"



**Winged Bayonet Caps**

DESCRIPTION	PART #	PRICE ea.
Winged bayonet caps, ID, IS, DF, FL, 10 mm across flats	Y8253049	black
Winged bayonet caps, TR, ITR, poly FT, round	Y8253050	black
Winged bayonet caps, poly FT self aligning	Y8253051	black
Winged bayonet caps, closed	Y8253040	black
Winged bayonet caps, 8 mm/10 mm Universal	Y8253080	black
Replacement W B Cap gaskets	YG00002020	black



**Spray Tip Filters**

DESCRIPTION	PART #	
Nozzle filters, poly, stainless screen, 50 mesh	Y8139002	blue
Nozzle filters, poly, stainless screen, 100 mesh	Y8139003	green
Nozzle filters, poly, 50 mesh, stainless screen, w/ check valve	Y8139004	blue
Nozzle filters, poly, 100 mesh, stainless screen, w/ check valve	Y8139005	green
Nozzle filters, brass, 50 mesh, stainless screen, w/ check valve	Y8139009	brass
Nozzle filters, brass, 100 mesh, stainless screen, w/ check valve	Y8139010	brass
Nozzle filters, brass, stainless screen, 50 mesh	Y8139011	brass
Nozzle filters, brass, stainless screen, 100 mesh	Y8139012	brass

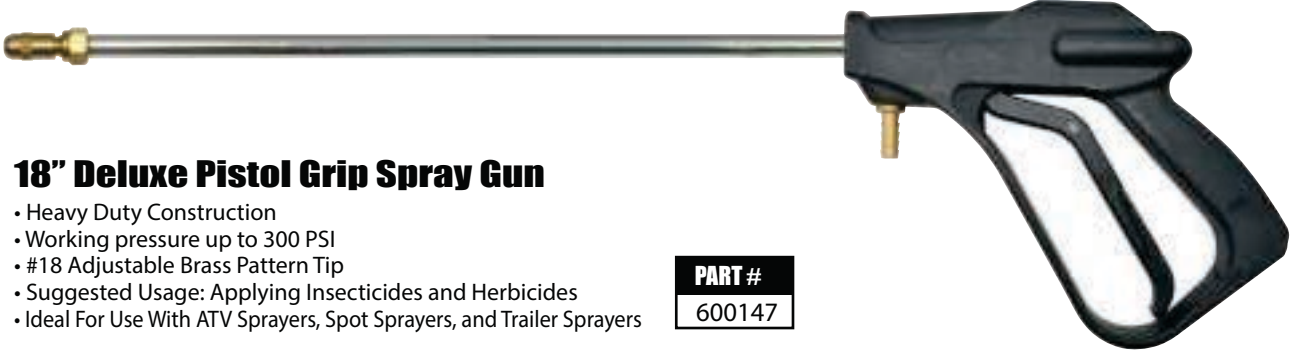

**18" Deluxe Pistol Grip Spray Gun**

- Heavy Duty Construction
- Working pressure up to 300 PSI
- #18 Adjustable Brass Pattern Tip
- Suggested Usage: Applying Insecticides and Herbicides
- Ideal For Use With ATV Sprayers, Spot Sprayers, and Trailer Sprayers

**PART #**  
600147



**Spot Spray Gun**

- Spray Gun with #18 orifice
- 18" overall length
- 3/8" hose barb connection
- Filter in handle
- Working pressure 200 PSI

**PART #**  
600227

## 2-Way Solenoid Valves

### Large Solenoid Valve

12-Volt DC Electric Boom Shutoff Valves have a 3/4" NPT Female inlet, 3/4" NPT male bypass outlet and a 1/2" NPT female boom outlet.

This direct operating valve is designed for 100 PSI maximum operating pressure and 10GPM. (only 5 PSI pressure is lost @ 10 GPM)

- Draws 2 amps per valve at 12 volts.
- Viton seals and o-rings.
- Wetted parts are made of 430 SS and glass filled nylon.

PART #	DESCRIPTION
2500B1	Solenoid Shutoff Valve, Single
2352	Repair Kit for 2500B-1 Solenoid Valve

### Manual Valve

2750 Manual Valve

This manual valve has a 3/4" NPT male and female inlet and bypass and a 1/2" NPT female boom outlet.

- 0-10 GPM, 175 PSI
- Viton Seals and o-rings.
- Wetted parts are made of 302 SS and glass filled nylon.

*\*The 2750 is a manual valve with a 1/4" NPT pump pressure point that needs to be drilled to function.*

PART	DESCRIPTION
2750	Manual Shutoff Valve



## Wiring Harnesses

- 96" wiring harness with on/off switch & 2-pin connector
- 12 volt

PART #	DESCRIPTION
WH101CA	12V with car adapter connection 7 amp tube fuse — 20 gauge wire
WH102BC	12V with 15 amp battery clips no fuse — 20 gauge wire
WH104	12V with car adapter & 15 amp battery clip 7 amp blade fuse — 18 gauge wire
WH105	12V with car adapter & 15 amp battery clip 15 amp mini blade fuse — 16 gauge wire
WH96EX	12V - 96" Wiring Harness Extension 18 gauge wire



WH101CA



WH102BC



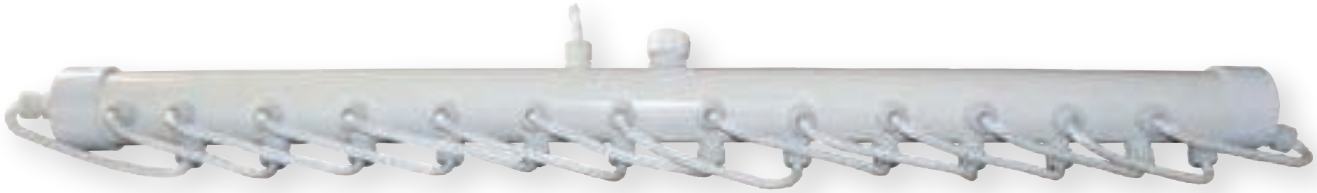

## String Wing

- Wick arrangement gives a double wipe which means an even application rate and a better kill.
- 5' sections help reduce wicks from drying out when applying on uneven ground where the wick bar is constantly tilted.
- Build any length applicator you want with the "String Wing"; the convenient 5' sections allow you to build 10', 15', 20', etc. sections.
- The special design of alternating wicks on the end cap means when you put "String Wings" end to end, you get full swath coverage; (No spots missed).
- Each "String Wing" has its own 1 1/4" fill opening and a breather to prevent vapor locking or pressure surges due to weather temperatures.

**PART #**  
SW

**Use with Your  
Choice of Herbicide  
& Wick Away  
Unwanted Weeds**



## Bucket Mount

**PART #**  
SWBM



**Easily Mounts  
String Wing  
to the Front  
of Any ATV**

## Reece Hitch Mount

Front or Rear Mount for 2" Receivers

**PART #**  
SWHM

**\*STRING WING SOLD SEPARATELY**



EG3434

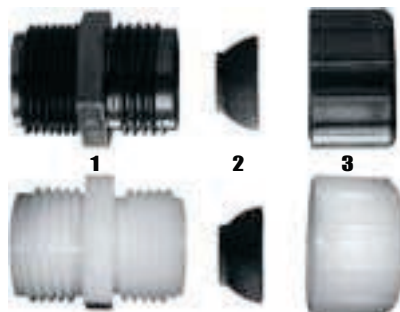

## Rope Wick Fitting

REF#	NYLON	PART #	POLY	DESCRIPTION
1	E3434	E3434P		3/4" Male GHT X 3/4" MPT Nylon
2	W407			Cone Washer
3	B3450	B3450P		3/4" Female GHT x 1/2" opening
3	B3458	B3458P		3/4" Female GHT x 5/8"
1, 2, 3	E3434C	E3434CP		1ea. E3434, B3450 & W407
EG3434	EG3434			Glue on Body. Designed to fit over 3" schedule 40 PVC pipe only.



## Wick Replacement Kit

PART #	DESCRIPTION
WK1	Wick replacement for String Wing, includes 14 each 18" wicks with 28 each B3450 fittings and W407 cone washers installed.
WK2	Wick Replacement Kit for a 20' wick bar. Parallel wick rows. Includes 50 each 18" wicks with 100 ea. B3450 fittings & W407 cone washers installed.
WK3	Wick Replacement includes 50 each 18" wicks. No fittings or cone washers. Wick ends are heat sealed.
WK4	1 - 18" Wick; 2 - B3450 fittings and 2 - W407 cone washers. Wick ends are heat sealed.
WK5	String Wing Do-It-Yourself Kit - 5ft. Includes 27-EG3434; 2-SW300CAP DWF; 1-WK1; 1-SW1140CAP; 1-M1140; 1-SW Breather
Wk10	String Wing Do-It-Yourself Kit - 10ft. Includes 54-EG3434; 2-SW300CAP DWF; 2-WK1; 1-SW1140CAP; 1-M1140; 1-SW Breather
Wk15	String Wing Do-It-Yourself Kit - 15ft. Includes 81-EG3434; 2-SW300CAP DWF; 3-WK1; 1-SW1140CAP; 1-M1140; 1-SW Breather
Wk20	String Wing Do-It-Yourself Kit - 20ft. Includes 108-EG3434; 2-SW300CAP DWF; 4-WK1; 1-SW1140CAP; 1-M1140; 1-SW Breather

## Weed Thief

- Robs garden of unwelcome weeds
- Rids lawn of dandelions
- Cleans fence rows
- Kills weeds in row crops
- Easy to use
- Lightweight 2 1/2 pounds when filled
- Economical

### PART #

WT1

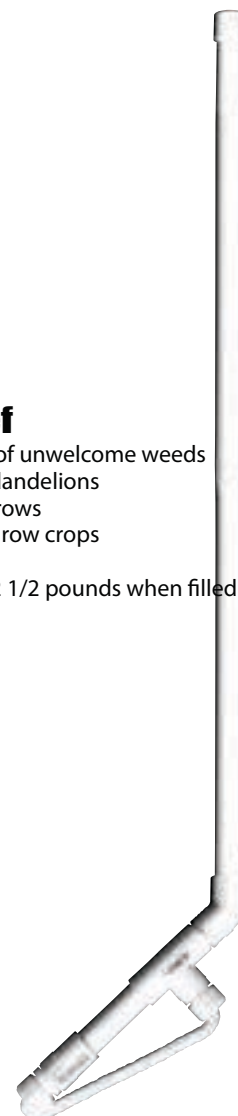

## Adapter

This fitting was used in early model rope wick applicators. Requires the use of N1116 Nut and either an "O" ring for wick bar use or a W406 washer if used as a tank fitting. ("O" rings are special order)



PART #	THREAD
NYLON	POLY
1116B	1116BP
11/16"	

## Cone Washer

Used for sealing wick in fitting. Fits 1/2" or 5/8" wick material.

### PART #

W407





# TERREMAX<sup>®</sup>

## LIQUID HANDLING PRODUCTS

### Develop. Depend. Deliver.

TerreMax pledges to be committed to its distributors and the agricultural market by developing new products, providing quality product assurance, and delivering superior customer service.

#### PRICING

All prices are subject to change without notice. Orders will be invoiced at current prices on the date shipment is made. All prices are F.O.B. TerreMax.

#### TERMS

An invoice is a contract in which TerreMax terms will prevail. Unless otherwise stated, payment terms are net 30 days, (D.O.I.). TerreMax reserves the right to place a customer on credit hold if deemed necessary. Up to a 5% service charge will be added per month on all past due accounts.

#### ORDERING

Please order by TerreMax's part number.

US Orders: A \$10.00 handling charge will be added to all orders under \$100.00.

International Orders: A \$25.00 processing fee will be added to all orders under \$200.00.

#### NEW ACCOUNTS

TerreMax welcomes all new accounts. TerreMax will provide a credit application for new customers to establish an open account. When opening an account the customer agrees to pay invoices in 30 days, pay up to a 5% service charge monthly on any invoices 31 days or older, and to pay any and all collection agencies, attorney fees and/or court fees necessary to collect on the account.

#### SHIPPING

Please notify us with your shipping instructions. Freight, air, parcel post or UPS. If no instruction is given, we will send best way. Freight shipments should be specified, via truck or rail, with line preference. A handling/service charge of \$2.00 will be added to all invoices.

#### SAME DAY SHIPMENTS

Same day shipments will incur a service charge of \$10.00 or 5%, whichever is greater.

#### WEIGHT VARIANCE

To control the cost of processing your orders, TerreMax uses electronic counting scales. It is our policy to have each scale certified for accuracy on a schedule recommended by the scale manufacturer. Electronic scales have an accuracy range that is acceptable by most of our customers. If your policy does not allow for a small overage/underage, please contact our marketing department and advise them that you require 100% accuracy of all quantities. Your account will be marked as hand count only. There is a charge of plus 5% of order value for all orders processed in this manner.

#### RETURNED GOODS POLICY

Returns must be received within 30 days from shipment and must be approved by TerreMax. A document with our return authorization number (RMA Number) and ship to address will be faxed, emailed or mailed to the customer. Any goods returned that do not have this document clearly attached to the outside of the carton will be refused. All returns must be freight prepaid. A 20% minimum restocking fee will be assessed to all returns. Returns will only be accepted if the products are in new and original condition, and contain no markings or labels other than TerreMax.

#### SHORTAGES

Claims must be made within 30 days after receipt of shipment; otherwise order will be considered shipped as ordered.

#### LOSS OR DAMAGE

In order to expedite your shipment to its destination in good condition, all orders are packed and shipped with care. TerreMax assumes no responsibility for items lost or damaged in transit. Claims will be made with carriers immediately. The purchaser is responsible for claims on freight collect shipments.

#### GUARANTEE

TerreMax warrants all merchandise to be as represented in our catalog. We will replace or make satisfactory adjustment if found otherwise.

#### USE OF PRODUCTS

Products manufactured by TerreMax and illustrated within this catalog are produced using resins that are prime and certifiable in grade. The chemical resistance & physical properties of these resins are available from TerreMax's engineering department. Improper use of these products could result in environmental spills, serious injury or death.

#### MATERIALS

As stated, TerreMax's stock fittings are always manufactured using quality prime resins; however, in order to insure that we continue to provide the best value to our customers, we reserve the right to change specific grades and/or manufacturers of resin without notice. Please keep this in mind when specifying our stock fittings for use in your applications. Due to the infinite end use possibilities of our products, the customer is responsible for determining the suitability of our products for their application. Data sheets indicating the manufacturer, grade, and properties of current production materials are available and may be requested at anytime. Should your application require a specific material, please contact our sales department for a custom quotation.

TerreMax is a division of Green Leaf, Incorporated — [www.green-leaf.us](http://www.green-leaf.us)

SCAN &  
DOWNLOAD  
YOUR COPY

**TERREMAX**<sup>®</sup>  
LIQUID HANDLING PRODUCTS

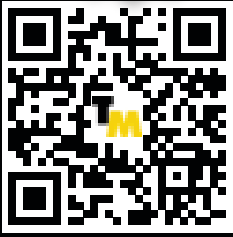

9490 N. Baldwin Street  
Fontanet, IN 47851

P: 833-809-6983  
F: 812-877-4278

Web: [www.terremax.us](http://www.terremax.us)  
E: [sales@terremax.us](mailto:sales@terremax.us)



**Develop.**



**Depend.**



**Deliver.**